

**ISISO**<sup>®</sup>

ISISO ENDÜSTRİYEL OTOMASYON ÜRÜNLERİ



2023  
**EYLÜL**

[www.soyluotomasyon.com](http://www.soyluotomasyon.com)

**soylu** *elektrik  
otomasyon*

# İÇİNDEKİLER

Hız Kontroller	01
Fren Dirençleri	01
Servo Motor & Sürücüler	02
INES - ISP Serisi Delikli Ray Tipi Güç Kaynakları	04
Güç Kaynakları & Mini Göstergeli Raya Montajlı Switching Güç Kaynakları	05
Raya Montajlı Switching Güç Kaynakları	06
Bayonet Tip, Fe-Const'lar, Pt-100'ler, NiCr-Niler	08
Kafalı Tip Fe-Const Termokupller	09
Kafalı Tip PT-100'ler Termokupller	10
Kafalı Tip NiCr-Ni'ler	11
Mantel Tip Fe-Const'lar, PT-100'ler, Nicr-Niler	12
SKP, Manifold, Özel Tip Termokupllar & Termokupl Kabloları	13
Termokupl El Problemleri & Termokupl Analog Çeviriciler	15
Termokupl Fiş ve Prizleri	16
Isı Ayarlı Sıcak Hava Tabancası & Lazer ve Temaslı Tip El Takometreleri & El Tipi Lazer Termometre, El Tipi Termometre	17
Genişletilmiş Algılamalı M4, M5, M6.5, M8, M12 Proximity Sensörler	19
Genişletilmiş Algılamalı M18, M30 Proximity Sensörler	20
Kübik Tip İndüktif Sensörler & Kapasitif Sensörler	21
B32 Serisi & B50 Serisi Prizmatik Fotoseller & Renk Fotoselleri	22
Cisimden Yansımali & Reflektörlü Fotoseller	23
Piston Manyetik Sensörler & Işık Bariyerleri	24
Dijital Göstergeli AMFi ve Kabloları & Konnektörlü Kablolar & Reflektörler	25
Solid State Röleler (SSR'ler)	27
Analog Girişli Monofaze Lineer SSR'ler & Trifaze Lineer SSR'ler & Ray Montajlı Soğutucular	28
Ray Montajlı Soğutuculu SSR & Potansiyometre ile Sürülebilir SSR & DC Giriş-Çıkış & SSR'ler	29
Butonlar (Plastik Seri)	31
Botunlar (Metal Seri)	32
Buton Işık Konağı & Sinyal Lambaları & Ampermetre & Voltmetre & Buzzer	33
Ø70mm Işıklı Kolonlar & Ø53mm Işıklı Kolonlar	34
Ø60 Borulu İkaz Lambaları & Ø50 İkaz Lambaları & Motorlu Sirenler & Çap 22mm Potansiyometre	35
El Aletleri	37
ISO Zupper El Aletleri & Kablo Kesme Makasları	38
İzoleli Kablo Yüksükleri Fransız Normu (Tek - Çift Girişli)	39
İzoleli Kablo Yüksükleri Alman Normu (Tek - Çift Girişli) & İzolesiz Kablo Yüksükleri	40
İzoleli Kablo Yüksükleri (Yuvarlak - Çatal Tip)	41
İzoleli Kablo Yüksükleri	42
İzolesiz Kablo Ucu ve Konnektörleri & Yapışkanlı Kroşeler	43
Standart Kablo Bağları	44
Cam Elyaf İzoleli Makaronlar & Kablo Toplama Çorabı & İçi Yapışkanlı Daralan Makaron	45
Isı ile Daralan Makaronlar & Sarı Yeşil Daralan Makaronlar	46
Isı ile Daralan Renkli Makaronlar & Isı ile Daralan Kahverengi Makaronlar	47
SKP Kablo Pabucları & BiMetal (Al-Cu) Kablo Pabucu	48
Polyamid Rakorlar & PG Dış Geçmeli Tip Spiral Rakorlar & Polyamid Körtapa & Polyamid Somun & Polyamid Kapaklı Kroşeler	49
Pano İçi Termostatlar & Endüstriyel Fanlar ve Filtreler	51
Plastik Gövde Limit Switchler	52
Metal Gövde Switchler, Kablolü Mini Switch & Emniyet Switchler, Pedallar	53
Mini Switchler & Mikro Switch & Güç Anahtarı & Toggle Anahtar	54
SİAF Silikon Kablo, SİAF-GL Cam İplik Örgülü Kablo & SİMH-Silikon Kablo & Pano İçi Aydınlatma Ledleri & Uyarı ve İkaz Etiketleri	55



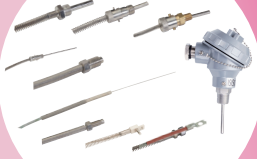

08 - 13

TERMOKUPLLAR



04 - 06

GÜÇ KAYNAKLARI



01 - 02

HIZ KONTROLLER  
SERVO MOTOR SÜRÜCÜ



15 - 16

TERMOKUPL FIŞ PRİZLERİ  
KAFA İÇİ ÇEVİRİCİLER

HAVA TABANCASI  
EL TİPİ TERMOMETRELER  
TAKOMETRELER



17

**ISISO**<sup>®</sup>

ISISO ENDÜSTRİYEL OTOMASYON ÜRÜNLERİ



19 - 25

SENSÖRLER, FOTOSELLER  
PİSTON SENSÖRLERİ  
REFLEKTÖRLER

SSR  
ANALOG GİRİŞLİ SSR'LER  
SOĞUTUCULAR



27 - 29

BUTONLAR  
SİNYAL LAMBALARI  
İKAZ LAMBALARI  
POTANSİYOMETRE



31 - 35

SİLİKON  
CAM ELYAF KABLOLAR  
LED AYDINLATMA  
UYARI ETİKETLERİ



55

YÜKSÜKLER, RAKORLAR  
KABLO BAĞLARI  
EL ALETLERİ, SKP PABUÇLAR  
MAKARONLAR

SWITCHLER  
PEDALLAR  
FANLAR



51 - 54



37 - 49



### Tek Faz 220Vac, için

- Yüksek tork ile başlama
- VIF veya vektör kontrolü
- 5 adet programlanabilen dijital giriş
- 1 adet programlanabilir röle çıkışı
- 1 adet programlanabilir transistör çıkışı
- 1 adet (0-10v) veya (0-20mA) analog çıkış
- 1 adet (0/2-10v) veya (0/4-20mA) analog çıkış
- PID fonksiyonu
- MODBUS (RS 485) haberleşme portu
- Dahili DC fren kısıcı
- Taşınabilir kontrol paneli

### Üç Faz 380Vac, için

- Yüksek tork ile başlama
- VIF veya vektör kontrolü
- 8 adet programlanabilen dijital giriş
- 2 adet programlanabilir röle çıkışı
- 2 adet programlanabilir transistör çıkışı
- 2 adet (0-10v) veya (0-20mA) analog çıkış
- 2 adet (0/2-10v) veya (0/4-20mA) analog çıkış
- PID fonksiyonu
- Basit PLC fonksiyonu
- MODBUS (RS 485) haberleşme portu
- Dahili DC fren kısıcı
- Fan-Pompa çalışma seçimi
- Taşınabilir kontrol paneli



Not: ■ 37 kW üstü fren drençleri için fiyat isteyiniz.

Model	Güç	Fiyat
<b>Tek Faz 220Vac</b>		
6000M-S2R4GB	0.40 kw	135 \$
6000M-S2R75GB	0.75 kw	160 \$
6000M-S21R5G	1.5 kw	200 \$
6000M-S22R2GB	2.2 kw	250 \$
<b>Üç Faz 380Vac</b>		
	<b>Ağır Şart / Normal Şart</b>	
6000E-3R75GB/31R5PB	0.75 / 1.5 kw	240 \$
6000E-31R5GB/32R2PB	1.5 / 2.2 kw	250 \$
6000E-32R2GB/3004PB	2.2 / 4 kw	290 \$
6000E-3004GB/35R5PB	4 / 5.5 kw	325 \$
6000E-35R5GB/37R5PB-N	5.5 / 7.5 kw	415 \$
6000E-37R5GB/3011PB	7.5 / 11 kw	480 \$
6000E-3011GB/3015PB-N	11 / 15 kw	600 \$
6000E-3015GB/3018PB-N	15 / 18.5 kw	760 \$
6000E-3018G/3022PB-N	18.5 / 22 kw	885 \$
6000E-3022GB-N	22 / 30 kw	1040 \$
6000E-3030G/3037P-N	30 / 37 kw	1370 \$
6000E-3037G/3045P-N	37 / 45 kw	1665 \$
6000E-3045G/3055P-N	45 / 55 kw	1935 \$
6000E-3055G/3075P-N	55 / 75 kw	2240 \$
6000E-3075G/3093P	75 / 90 kw	3120 \$
6000E-3093G/3010P	90 / 110 kw	4500 \$
6000E-3110G/3132P	110 / 132 kw	5500 \$
6000E-3132G/3160P	132 / 160 kw	6500 \$
6000E-3160G/3185P	160 / 185 kw	8900 \$

Model	Açıklama	Fiyat
<b>Tek Faz 220Vac</b>		
IPM	MONOFAZE HIZ KONTROL İÇİN UZAĞA TAŞIMA PANELİ	48 \$
IPT	TRİFAZE HIZ KONTROL İÇİN UZAĞA TAŞIMA PANELİ	58 \$

## Fren Dirençleri

Volta(j)v	Motor Gücü(kw)	Direnci Ω	Direnç Gücü (w)	Kod	Fiyat
Tek faz 220 0.5	0.4 kw	200 Ω	100w	IMR0.4-200-0.1	50 \$
	0.75 kw	150 Ω	200w	IMR0.75-150-0.2	50 \$
	1.5 kw	100 Ω	400w	IMR1.5-100-0.4	50 \$
	2.2 kw	75 Ω	500w	IMR2.2-75-0.5	50 \$
Üç faz 380	0.75 kw	300 Ω	400w	ITR0.75-300-0.4	50 \$
	1.5 kw	300 Ω	400w	ITR1.5-300-0.4	50 \$
	2.2 kw	200 Ω	500w	ITR2.2-200-0.5	50 \$
	4.0 kw	200 Ω	500w	ITR4-200-0.5	50 \$
	5.5 kw	100 Ω	800w	ITR5.5-100-0.8	60 \$
	7.5 kw	75 Ω	800w	ITR7.5-75-0.8	60 \$
	11 kw	50 Ω	1.000w	ITR11-50-1	60 \$
	15 kw	40 Ω	1.500w	ITR15-40-1.5	60 \$
	18.5 kw	30 Ω	4.000w	ITR18.5-30-4	250 \$
	22 kw	30 Ω	4.000w	ITR22-30-4	250 \$
	30 kw	20 Ω	6.000w	ITR30-20-0.6	300 \$
	37 kw	16 Ω	9.000w	ITR37-16-9	425 \$

Ürün Kodu	Açıklama	Fiyat	
ASMS-R40B30U2R	MOTOR 400W 1/3 Faz 220vac 1,27 N/m 3000Rpm 60 Flanş Ø14mm Mil	295 \$	
AS-100A-2R8M2U	SÜRÜCÜ 400W 1/3 Faz 220vac	385 \$	
CB100E-E-3000	400 W ENKODER KABLOSU 3mt	34 \$	
CB100M-E-3000	400 W MOTOR KABLOSU 3mt	18 \$	
CB100E-E-5000	400 W ENKODER KABLOSU 5mt	46 \$	
CB100M-E-5000	400 W MOTOR KABLOSU 5mt	35 \$	
CB100E-E-10000	400 W ENKODER KABLOSU 10mt	76 \$	
CB100M-E-10000	400 W MOTOR KABLOSU 10mt	66 \$	
CB100E-E-15000	400 W ENKODER KABLOSU 15mt	84 \$	
CB100M-E-15000	400 W MOTOR KABLOSU 15mt	68 \$	
400W FRENSİZ TAKIM / 3mt	732 \$	400W FRENSİZ TAKIM / 5mt	761 \$
400W FRENSİZ TAKIM / 10mt	822 \$	400W FRENSİZ TAKIM / 15mt	832 \$
ASMS-R75B30U2R	MOTOR 750W 1/3 Faz 220vac 2,39 N/m 3000Rpm 80 Flanş Ø19mm Mil	330 \$	
AS-100A-3R8M2U	SÜRÜCÜ 750W 1/3 Faz 220vac	410 \$	
CB100E-E-3000	750 W ENKODER KABLOSU 3mt	34 \$	
CB100M-E-3000	750 W MOTOR KABLOSU 3mt	18 \$	
CB100E-E-5000	750 W ENKODER KABLOSU 5mt	46 \$	
CB100M-E-5000	750 W MOTOR KABLOSU 5mt	35 \$	
750W FRENSİZ TAKIM / 3mt	792 \$	750W FRENSİZ TAKIM / 5mt	821 \$
750W FRENSİZ TAKIM / 10mt	882 \$	750W FRENSİZ TAKIM / 15mt	892 \$
ASMH-1R0B25U2R	MOTOR 1 KW 1/3 Faz 220vac 4 N/m 2500Rpm 130 Flanş Ø22mm Mil	490 \$	
AS-100A-5R5M2U	SÜRÜCÜ 1 KW 1/3 Faz 220vac	453 \$	
CB100E-F-3000	1 KW ENKODER KABLOSU 3mt	56 \$	
CB100M-F-3000	1 KW MOTOR KABLOSU 3mt	36 \$	
CB100E-F-5000	1 KW ENKODER KABLOSU 5mt	68 \$	
CB100M-F-5000	1 KW MOTOR KABLOSU 5mt	48 \$	
CB100E-F-10000	1 KW ENKODER KABLOSU 10mt	88 \$	
CB100M-F-10000	1 KW MOTOR KABLOSU 10mt	68 \$	
CB100E-F-15000	1 KW ENKODER KABLOSU 15mt	108 \$	
CB100M-F-15000	1 KW MOTOR KABLOSU 15mt	88 \$	
1 KW FRENSİZ TAKIM / 3mt	1.035 \$	1 KW FRENSİZ TAKIM / 5mt	1.059 \$
1 KW FRENSİZ TAKIM / 10mt	1.099 \$	1 KW FRENSİZ TAKIM / 15mt	1.139 \$
ASMG-1R5B25U2R	MOTOR 1,5 KW 1/3 Faz 220vac 6 N/m 2500Rpm 130 Flanş Ø22mm Mil	450 \$	
AS-100A-7R6T2U	SÜRÜCÜ 1,5 KW 1/3 Faz 220vac	563 \$	
CB100E-F-3000	1,5 KW ENKODER KABLOSU 3mt	56 \$	
CB100M-F-3000	1,5 KW MOTOR KABLOSU 3mt	36 \$	
CB100E-F-5000	1,5 KW ENKODER KABLOSU 5mt	48 \$	
CB100M-F-5000	1,5 KW MOTOR KABLOSU 5mt	68 \$	
1,5 KW FRENSİZ TAKIM / 3mt	1107 \$	1,5 KW FRENSİZ TAKIM / 5mt	1129 \$
1,5 KW FRENSİZ TAKIM / 10mt	1169 \$	1,5 KW FRENSİZ TAKIM / 15mt	1209 \$
ASMG-2R0B25U2R	MOTOR 2 KW 1/3 Faz 220vac 7,7 N/m 2500Rpm 130 Flanş Ø22mm Mil	600 \$	
AS-100A-7R6T2U	SÜRÜCÜ 2 KW 1/3 Faz 220vac	563 \$	
CB100E-F-3000	2 KW ENKODER KABLOSU 3mt	56 \$	
CB100M-F-3000	2 KW MOTOR KABLOSU 3mt	36 \$	
CB100E-F-5000	2 KW ENKODER KABLOSU 5mt	68 \$	
CB100M-F-5000	2 KW MOTOR KABLOSU 5mt	48 \$	
2 KW FRENSİZ TAKIM / 3mt	1255 \$	2 KW FRENSİZ TAKIM / 5mt	1279 \$
2 KW FRENSİZ TAKIM / 10mt	1319 \$	2 KW FRENSİZ TAKIM / 15mt	1359 \$

- Tork kontrolü
- Hız kontrolü
- Pozisyon kontrolü
- 7 adet programlanabilen NPN dijital giriş
- 4 adet programlanabilen dijital çıkış
- 1 adet (0-10v) analog giriş
- Pals ile sürebilme
- Dahili pozisyonlama
- Enkoder çıkışı
- RS 485 ile MODIBUS haberleşme
- HOMINE Fonksiyonu







ISISO ENDÜSTRİYEL OTOMASYON ÜRÜNLERİ

# Delikli ve Ray Tipi Güç Kaynakları

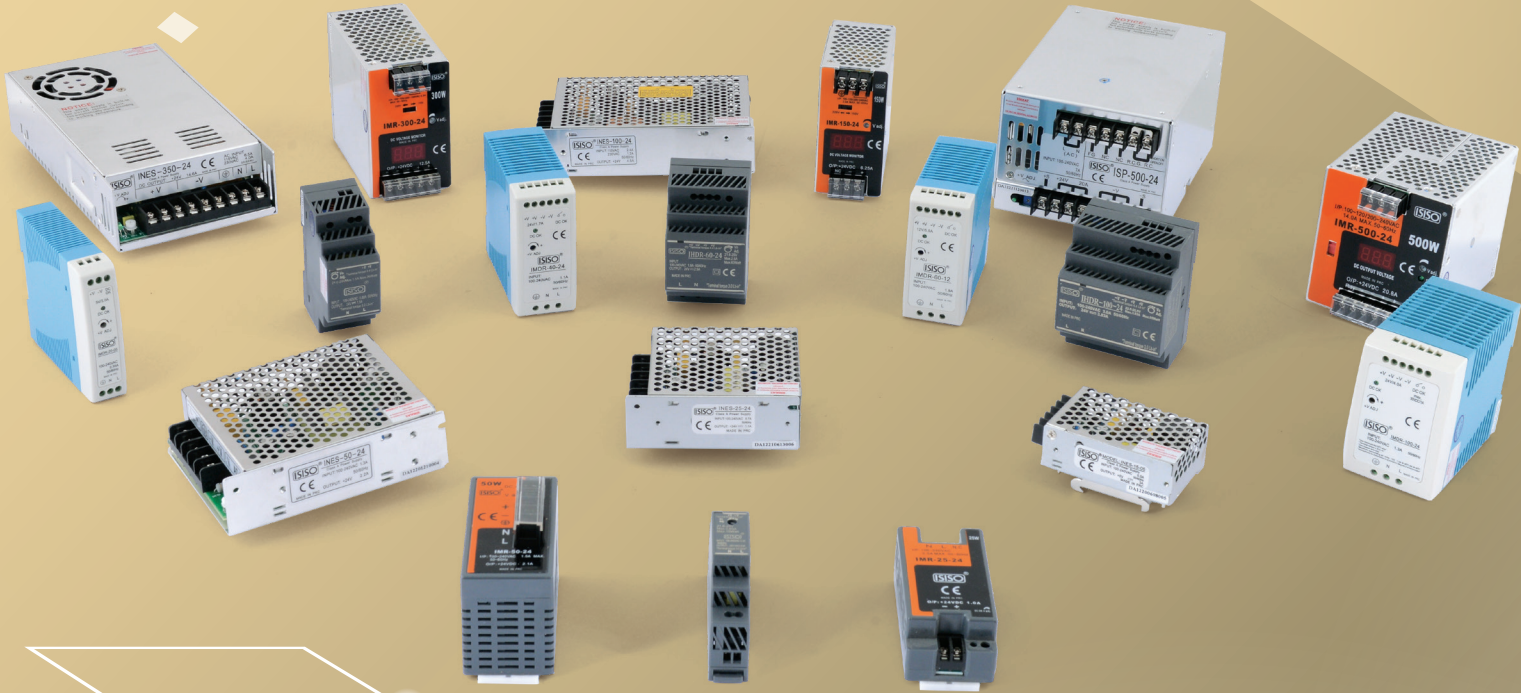

## Ray Montajlı Kapalı Tip (Delikli) Switching Güç Kaynakları

- Düşük Fiyat ve Yüksek Güvenilirlik
- Yüksek Verimlilik ve Düşük Çalışma Sıcaklığı
- Kısa Devre ve Aşırı Yük Koruması

GÜÇ KAYNAKLARI



Model	Güç	Çıkış	Amper	Boyut	Fiyat
INES-15-05	15 W	5 VDC	3.0 A	78*51*28 mm	11 \$
INES-15-12	15 W	12 VDC	1.3 A	78*51*28 mm	11 \$
INES-15-24	15 W	24 VDC	0.7 A	78*51*28 mm	11 \$
INES-25-05	25 W	5 VDC	5.0 A	99*82*35 mm	15 \$
INES-25-12	25 W	12 VDC	2.1 A	99*82*35 mm	15 \$
INES-25-24	25 W	24 VDC	1.1 A	99*82*35 mm	15 \$
INES-50-05	50 W	5 VDC	10.0 A	129*98*38 mm	18 \$
INES-50-12	50 W	12 VDC	4.2 A	129*98*38 mm	18 \$
INES-50-24	50 W	24 VDC	2.1 A	129*98*38 mm	17 \$
INES-75-05	75 W	5 VDC	15.0 A	159*97*38 mm	20 \$
INES-75-12	75 W	12 VDC	6.3 A	159*97*38 mm	20 \$
INES-75-24	75 W	24 VDC	3.2 A	159*97*38 mm	19 \$
INES-100-05	100 W	5 VDC	20.0 A	159*97*38 mm	22 \$
INES-100-12	100 W	12 VDC	8.5 A	159*97*38 mm	22 \$
INES-100-24	100 W	24 VDC	4.5 A	159*97*38 mm	20 \$
INES-100-48	100 W	48 VDC	2.0 A	159*97*38 mm	22 \$
INES-150-12	150 W	12 VDC	12.5 A	159*97*38 mm	31 \$
INES-150-24	150 W	24 VDC	6.5 A	159*97*38 mm	29 \$
INES-150-48	150 W	48 VDC	3.2 A	159*97*38 mm	31 \$
INES-201-12	200 W	12 VDC	16.5 A	215*115*50 mm	42 \$
INES-201-24	200 W	24 VDC	8.3 A	215*115*50 mm	39 \$
INES-201-48	200 W	48 VDC	4.2 A	215*115*50 mm	42 \$
INES-350-12	350 W	12 VDC	29.0 A	215*115*50 mm	50 \$
INES-350-24	350 W	24 VDC	14.6 A	215*115*50 mm	50 \$
INES-350-48	350 W	48 VDC	7.3 A	215*115*50 mm	50 \$
ISP-500-12	500 W	12 VDC	40.0 A	170*120*93 mm	120,00 \$
ISP-500-24	500 W	24 VDC	20.0 A	170*120*93 mm	120,00 \$
ISP-500-48	500 W	48 VDC	10.5 A	170*120*93 mm	120,00 \$



Tüm INES & ISP serileri RAY Montajlıdır!





## Raya Montajlı Switching Güç Kaynakları

- Düşük Fiyat ve Yüksek Güvenirlik
- Yüksek Verimlilik ve Düşük Çalışma Sıcaklığı
- Kısa Devre ve Aşırı Yük Koruması

Model	Güç	Çıkış	Amper	Boyut		Fiyat
				En	Boy Yükseklik	
INLP-40-12	40 W	12 VDC	3.3	45*102	35 mm	16,00 \$
INLP-40-24	40 W	24 VDC	1.67	45*102	35 mm	16,00 \$
INLP-50-12	50 W	12 VDC	3.6	45*102	35 mm	17,50 \$
INLP-50-24	50 W	24 VDC	2.08	45*102	35 mm	17,50 \$
INLP-75-12	75 W	12 VDC	6.3	45*102	75 mm	25,50 \$
INLP-75-24	75 W	24 VDC	3.2	45*102	75 mm	25,50 \$
INLP-100-12	100 W	12 VDC	8.3	45*102	75 mm	27,00 \$
INLP-100-24	100 W	24 VDC	4.1	45*102	75 mm	27,00 \$
INLP-200-12	200 W	12 VDC	16.5	49*100	83 mm	45,00 \$
INLP-200-24	200 W	24 VDC	8.3	49*100	83 mm	45,00 \$
INLP-240-12	240 W	12 VDC	20.0	49*100	83 mm	47,00 \$
INLP-240-24	240 W	24 VDC	10.0	49*100	83 mm	47,00 \$
INLP-360-24	360 W	24 VDC	15.0	60*110	100 mm	67,00 \$
INLP-360-48	360 W	48 VDC	7.5	60*110	100 mm	67,00 \$
INLP-480-12	480 W	12 VDC	40.0	60*110	100 mm	75,00 \$
INLP-480-24	480 W	24 VDC	20.0	60*110	100 mm	75,00 \$

## Mini Göstergeli Raya Montajlı Switching Güç Kaynakları

- Düşük Fiyat ve Yüksek Güvenirlik
- Yüksek Verimlilik ve Düşük Çalışma Sıcaklığı
- Kısa Devre ve Aşırı Yük Koruması



Model	Güç	Çıkış	Amper	Boyut		Fiyat
				En	Boy Yükseklik	
IMR-25-05	25 W	5 VDC	5 A	35*45	90 mm	19.00 \$
IMR-25-12	25 W	12 VDC	2.1 A	35*45	90 mm	19.00 \$
IMR-25-24	25 W	24 VDC	1.1 A	35*45	90 mm	19.00 \$
IMR-50-05	50 W	5 VDC	10 A	75.5*45	102 mm	23.00 \$
IMR-50-12	50 W	12 VDC	4.2 A	75.5*45	102 mm	23.00 \$
IMR-50-24	50 W	24 VDC	2.1 A	75.5*45	102 mm	23.00 \$
IMR-100-12	100 W	12 VDC	8.3 A	83*49	100 mm	34.00 \$
IMR-100-24	100 W	24 VDC	4.2 A	83*49	100 mm	34.00 \$
IMR-150-12	150 W	12 VDC	12.5 A	83*49	100 mm	43.00 \$
IMR-150-24	150 W	24 VDC	6.25 A	83*49	100 mm	43.00 \$
IMR-150-48	150 W	48 VDC	3.10 A	83*49	100 mm	43.00 \$
IMR-300-12	300 W	12 VDC	25.0 A	100*60	110 mm	65.00 \$
IMR-300-24	300 W	24 VDC	12.5 A	100*60	110 mm	65.00 \$
IMR-300-48	300 W	48 VDC	6.25 A	100*60	110 mm	65.00 \$
IMR-500-12	500 W	12 VDC	37.5 A	100*90	110 mm	92.00 \$
IMR-500-24	500 W	24 VDC	20.8 A	100*90	110 mm	92.00 \$
IMR-500-48	500 W	48 VDC	10.4 A	100*90	110 mm	92.00 \$

# Raya Montajlı Switching Güç Kaynakları

- Düşük Fiyat ve Yüksek Güvenirlik
- Yüksek Verimlilik ve Düşük Çalışma Sıcaklığı
- Kısa Devre ve Aşırı Yük Koruması

GÜÇ KAYNAKLARI



Model	Güç	Çıkış	Amper	Boyut En	Boy Yükseklik	Fiyat
IMDR-20-05	20 W	5 VDC	3.0 A	22.5*90	100 mm	18.00 \$
IMDR-20-12	20 W	12 VDC	1.67 A	22.5*90	100 mm	18.00 \$
IMDR-20-24	20 W	24 VDC	1.0 A	22.5*90	100 mm	18.00 \$
IMDR-40-05	40 W	5 VDC	6.0 A	40*90	100 mm	25.00 \$
IMDR-40-12	40 W	12 VDC	3.3 A	40*90	100 mm	25.00 \$
IMDR-40-24	40 W	24 VDC	1.7 A	40*90	100 mm	25.00 \$
IMDR-60-05	60 W	5 VDC	10.0 A	40*90	100 mm	27.00 \$
IMDR-60-12	60 W	12 VDC	5.0 A	40*90	100 mm	27.00 \$
IMDR-60-24	60 W	24 VDC	2.5 A	40*90	100 mm	27.00 \$
IMDR-100-05	100 W	5 VDC	20.0 A	55.5*90	100 mm	40.00 \$
IMDR-100-12	100 W	12 VDC	8.5 A	55.5*90	100 mm	40.00 \$
IMDR-100-24	100 W	24 VDC	4.5 A	55.5*90	100 mm	40.00 \$



## Raya Montajlı Switching Güç Kaynakları

- Düşük Fiyat ve Yüksek Güvenirlik
- Yüksek Verimlilik ve Düşük Çalışma Sıcaklığı
- Kısa Devre ve Aşırı Yük Koruması

Model	Güç	Giriş	Çıkış	Amper	Boyut En	Boy Yükseklik	Fiyat
IHDR-15-05	15 W	220 VAC	5 VDC	3 A	25*91	56 mm	17.00 \$
IHDR-15-12	15 W	220 VAC	12 VDC	1.3 A	25*91	56 mm	17.00 \$
IHDR-15-24	15 W	220 VAC	24 VDC	0.7 A	25*91	56 mm	17.00 \$
IDR-30-12	30 W	220 VAC	12 VDC	2.0 A	78*93	56 mm	21.00 \$
IHDR-30-24	30 W	220 VAC	24 VDC	1.5 A	35*90	54,5 mm	21.00 \$
IDR-45-12	45 W	220 VAC	12 VDC	3.5 A	93*78	67 mm	22,00 \$
IDR-45-24	45 W	220 VAC	24 VDC	2.0 A	93*78	67 mm	22,00 \$
IDR-60-05	60 W	220 VAC	5 VDC	6.5 A	93*78	67 mm	29.00 \$
IDR-60-12	60 W	220 VAC	12 VDC	4.5 A	93*78	67 mm	29.00 \$
IHDR-60-24	60 W	220 VAC	24 VDC	2.5 A	52,5*90	54,5 mm	29.00 \$
IDR-75-12	75 W	220 VAC	12 VDC	6.3 A	55.5*125.2	100 mm	33,00 \$
IDR-75-24	75 W	220 VAC	24 VDC	3.2 A	55.5*125.2	100 mm	33,00 \$
IHDR-100-12	100 W	220 VAC	12 VDC	8.5 A	98*90	56 mm	37.00 \$
IHDR-100-24	100 W	220 VAC	24 VDC	4.5 A	98*90	56 mm	37.00 \$
IDR-120-12	120 W	220 VAC	12 VDC	10.0 A	65.5*125.2	100 mm	40,00 \$
IDR-120-24	120 W	220 VAC	24 VDC	5.0 A	65.5*125.2	100 mm	40,00 \$
IEDR-150-12	150 W	220 VAC	12 VDC	12.5 A	40*125.2	113,5 mm	36,40 \$
IEDR-150-24	150 W	220 VAC	24 VDC	6.5 A	40*125.2	113,5 mm	36,40 \$
IDRP-240-24	240 W	220 VAC	24 VDC	10.0 A	125.2*125.2	100 mm	64,00 \$
IDRP-240-48	240 W	220 VAC	48 VDC	5.0 A	125.2*125.2	100 mm	64,00 \$
IDRP-480-24	480 W	220 VAC	24 VDC	20.0 A	227*125.2	100 mm	145,00 \$
IDRP-480-48	480 W	220 VAC	48 VDC	10.0 A	227*125.2	100 mm	145,00 \$
IDRT-240-24	240 W	380 VAC	24 VDC	10.0 A	227*125.2	100 mm	96,00 \$
IDRT-480-24	480 W	380 VAC	24 VDC	20.0 A	227*125.2	100 mm	150,00 \$





ISISO ENDÜSTRİYEL OTOMASYON ÜRÜNLERİ



# Kafalı-Bayonet-Mantel & Özel Tip Termokupllar



www.soyluotomasyon.com

### Fe-Const'lar, PT-100'ler, Nitr-Ni'ler

- Düşük Fiyat, Yüksek Verimlilik ve Hassas Ölçüm
- Standart Dış Ölçüsü M12x1,75
- Sabit Kablo ve Tam İzoleli



Ürün Kodu	Eleman Cinsi	Boru Çapı (mm)	Dalma Boyu (mm)	Kablo Boyu (mt)	Termokupl Tipi	Fiyat
ETB30F06-1Ç	J	6	30	1	Fe-Const	4,50 €
ETB30F06-1,5Ç	J	6	30	1,5	Fe-Const	5,25 €
ETB30F06-2Ç	J	6	30	2	Fe-Const	6,00 €
ETB30F06-2,5Ç	J	6	30	2,5	Fe-Const	6,75 €
ETB30F06-3Ç	J	6	30	3	Fe-Const	7,50 €
ETB30F06-4Ç	J	6	30	4	Fe-Const	9,00 €
ETB30F06-5Ç	J	6	30	5	Fe-Const	10,50 €
ETB12F08-1Ç	J	8	12	1	Fe-Const	4,50 €
ETB12F08-1,5Ç	J	8	12	1,5	Fe-Const	5,25 €
ETB12F08-2Ç	J	8	12	2	Fe-Const	6,00 €
ETB12F08-2,5Ç	J	8	12	2,5	Fe-Const	6,75 €
ETB12F08-3Ç	J	8	12	3	Fe-Const	7,50 €
ETB12F08-4Ç	J	8	12	4	Fe-Const	9,00 €
ETB12F08-5Ç	J	8	12	5	Fe-Const	10,50 €
ETB30P06-1Ç	PT-100	6	30	1	PT-100	13 €
ETB30P06-1,5Ç	PT-100	6	30	1,5	PT-100	14 €
ETB30P06-2Ç	PT-100	6	30	2	PT-100	15 €
ETB30P06-2,5Ç	PT-100	6	30	2,5	PT-100	16 €
ETB30P06-3Ç	PT-100	6	30	3	PT-100	17 €
ETB30P06-4Ç	PT-100	6	30	4	PT-100	19,50 €
ETB30P06-5Ç	PT-100	6	30	5	PT-100	22,00 €
ETB12P08-1Ç	PT-100	8	12	1	PT-100	13 €
ETB12P08-1,5Ç	PT-100	8	12	1,5	PT-100	14 €
ETB12P08-2Ç	PT-100	8	12	2	PT-100	15 €
ETB12P08-2,5Ç	PT-100	8	12	2,5	PT-100	16 €
ETB12P08-3Ç	PT-100	8	12	3	PT-100	17 €
ETB12P08-4Ç	PT-100	8	12	4	PT-100	19,50 €
ETB12P08-5Ç	PT-100	8	12	5	PT-100	22,00 €
ETB30N06-1Ç	K	6	30	1	NiCr-Ni	9,50 €
ETB30N06-1,5Ç	K	6	30	1,5	NiCr-Ni	10,25 €
ETB30N06-2Ç	K	6	30	2	NiCr-Ni	11,00 €
ETB30N06-2,5Ç	K	6	30	2,5	NiCr-Ni	11,75 €
ETB30N06-3Ç	K	6	30	3	NiCr-Ni	12,50 €
ETB30N06-4Ç	K	6	30	4	NiCr-Ni	14,00 €
ETB30N06-5Ç	K	6	30	5	NiCr-Ni	15,50 €
ETB12N08-1Ç	K	8	12	1	NiCr-Ni	9,50 €
ETB12N08-1,5Ç	K	8	12	1,5	NiCr-Ni	10,25 €
ETB12N08-2Ç	K	8	12	2	NiCr-Ni	11,00 €
ETB12N08-2,5Ç	K	8	12	2,5	NiCr-Ni	11,75 €
ETB12N08-3Ç	K	8	12	3	NiCr-Ni	12,50 €
ETB12N08-4Ç	K	8	12	4	NiCr-Ni	14,00 €
ETB12N08-5Ç	K	8	12	5	NiCr-Ni	15,50 €



Not: Standart olan Fe-const ve PT-100 termokupllerde 5 mt'den sonra her metre kablo için listesine 2.4 €, Ni-CrNi termokupller ise 3€ eklenecektir. Özel ürünler için lütfen fiyat alınız.



## Fe-Const'lar

- Düşük Fiyat, Yüksek Verimlilik ve Hassas Ölçüm
- Ölçüm Sıcaklık Aralığı 0-600 °C'dir.
- Standart Dış Ölçüsü 1/2 Rakorludur.
- Standart Haricinde İstenilen Çap ve Boylarda Üretimi Yapılmaktadır.



Ürün Kodu	Eleman Cinsi	Boru Çapı (mm)	Dalma Boyu (mm)	Eleman Sayısı	Montaj Şekli	Fiyat
TCFK-231-6-50-1/2	J	6	50	TEK	1/2 RAKORLU	35,00 €
TCFK-231-6-100-1/2	J	6	100	TEK	1/2 RAKORLU	35,00 €
TCFK-231-6-150-1/2	J	6	150	TEK	1/2 RAKORLU	36,00 €
TCFK-231-6-200-1/2	J	6	200	TEK	1/2 RAKORLU	36,00 €
TCFK-231-6-250-1/2	J	6	250	TEK	1/2 RAKORLU	38,00 €
TCFK-231-6-300-1/2	J	6	300	TEK	1/2 RAKORLU	40,00 €
TCFK-231-6-350-1/2	J	6	350	TEK	1/2 RAKORLU	42,00 €
TCFK-231-6-400-1/2	J	6	400	TEK	1/2 RAKORLU	44,00 €
TCFK-231-6-450-1/2	J	6	450	TEK	1/2 RAKORLU	46,00 €
TCFK-231-6-500-1/2	J	6	500	TEK	1/2 RAKORLU	48,00 €
TCFK-231-8-50-1/2	J	8	50	TEK	1/2 RAKORLU	35,00 €
TCFK-231-8-100-1/2	J	8	100	TEK	1/2 RAKORLU	35,00 €
TCFK-231-8-150-1/2	J	8	150	TEK	1/2 RAKORLU	36,00 €
TCFK-231-8-200-1/2	J	8	200	TEK	1/2 RAKORLU	36,00 €
TCFK-231-8-250-1/2	J	8	250	TEK	1/2 RAKORLU	38,00 €
TCFK-231-8-300-1/2	J	8	300	TEK	1/2 RAKORLU	40,00 €
TCFK-231-8-350-1/2	J	8	350	TEK	1/2 RAKORLU	42,00 €
TCFK-231-8-400-1/2	J	8	400	TEK	1/2 RAKORLU	44,00 €
TCFK-231-8-450-1/2	J	8	450	TEK	1/2 RAKORLU	46,00 €
TCFK-231-8-500-1/2	J	8	500	TEK	1/2 RAKORLU	48,00 €

## Kompanzasyon Renk Kodları

IEC 584-3 ANSI/MS 96.1 DIN 43714

KOD	İLETKEN CİNSİ		ÖLÇÜM ARALIĞI	RENK KODLARI			
	(+)	(-)		IEC 584-3	ANSI/MS 96.1	DIN 43714	
J	J	DEMİR	KONSTANTAN	+20+700 °C			
K	K	NİKEL - KROM (Chromel)	NİKEL ALAŞIM (Alumel)	0+1100 °C			
T	T	BAKIR	KONSTANTAN	-185+300 °C			
N	N	NİKEL - KROM SLİKON (Nicrosil)	NİKEL - SLİKON MAGNESİUM (NISIL)	+0+1100 °C			
E	E	NİKEL - KROM (Chromel)	KONSTANTAN (Bakır-Nikel)	0+800 °C			
R	R	PLATİN 13 % RODYUM	PLATİN	0+1600 °C			
S	S	PLATİN 10 % RODYUM	PLATİN	0+1550 °C			
B	B	PLATİN 30 % RODYUM	PLATİN 10 % RODYUM	+100+1600 °C			



### PT-100'ler

- Düşük Fiyat, Yüksek Verimlilik ve Hassas Ölçüm
- Ölçüm Sıcaklık Aralığı -200,+600 °C'dir.
- Standart Dış Ölçüsü 1/2 Rakorludur.
- Standart Haricinde İstenilen Çap ve Boylarda Üretimi Yapılmaktadır.

Ürün Kodu	Eleman Cinsi	Boru Çapı (mm)	Dalma Boyu (mm)	Eleman Sayısı	Montaj Şekli	Fiyat
TRPT-231-6-50-1/2	PT-100	6	50	TEK	1/2 RAKORLU	36,00 €
TRPT-231-6-100-1/2	PT-100	6	100	TEK	1/2 RAKORLU	36,00 €
TRPT-231-6-150-1/2	PT-100	6	150	TEK	1/2 RAKORLU	38,00 €
TRPT-231-6-200-1/2	PT-100	6	200	TEK	1/2 RAKORLU	40,00 €
TRPT-231-6-250-1/2	PT-100	6	250	TEK	1/2 RAKORLU	42,00 €
TRPT-231-6-300-1/2	PT-100	6	300	TEK	1/2 RAKORLU	44,00 €
TRPT-231-6-350-1/2	PT-100	6	350	TEK	1/2 RAKORLU	46,00 €
TRPT-231-6-400-1/2	PT-100	6	400	TEK	1/2 RAKORLU	48,00 €
TRPT-231-6-450-1/2	PT-100	6	450	TEK	1/2 RAKORLU	51,00 €
TRPT-231-6-500-1/2	PT-100	6	500	TEK	1/2 RAKORLU	53,00 €
TRPT-231-8-50-1/2	PT-100	8	50	TEK	1/2 RAKORLU	36,00 €
TRPT-231-8-100-1/2	PT-100	8	100	TEK	1/2 RAKORLU	36,00 €
TRPT-231-8-150-1/2	PT-100	8	150	TEK	1/2 RAKORLU	38,00 €
TRPT-231-8-200-1/2	PT-100	8	200	TEK	1/2 RAKORLU	40,00 €
TRPT-231-8-250-1/2	PT-100	8	250	TEK	1/2 RAKORLU	42,00 €
TRPT-231-8-300-1/2	PT-100	8	300	TEK	1/2 RAKORLU	44,00 €
TRPT-231-8-350-1/2	PT-100	8	350	TEK	1/2 RAKORLU	46,00 €
TRPT-231-8-400-1/2	PT-100	8	400	TEK	1/2 RAKORLU	48,00 €
TRPT-231-8-450-1/2	PT-100	8	450	TEK	1/2 RAKORLU	51,00 €
TRPT-231-8-500-1/2	PT-100	8	500	TEK	1/2 RAKORLU	53,00 €
TRPT-231-8-550-1/2	PT-100	8	550	TEK	1/2 RAKORLU	55,00 €
TRPT-231-8-600-1/2	PT-100	8	600	TEK	1/2 RAKORLU	57,00 €
TRPT-231-8-650-1/2	PT-100	8	650	TEK	1/2 RAKORLU	59,00 €
TRPT-231-8-700-1/2	PT-100	8	700	TEK	1/2 RAKORLU	61,00 €
TRPT-231-8-800-1/2	PT-100	8	800	TEK	1/2 RAKORLU	65,00 €
TRPT-231-8-900-1/2	PT-100	8	900	TEK	1/2 RAKORLU	67,00 €
TRPT-231-8-1000-1/2	PT-100	8	1000	TEK	1/2 RAKORLU	69,00 €
TRPT-231-8-1200-1/2	PT-100	8	800	TEK	1/2 RAKORLU	71,00 €
TRPT2-231-8-050-1/2	2xPT-100	8	050	ÇİFT	1/2 RAKORLU	53,00 €
TRPT2-231-8-100-1/2	2xPT-100	8	100	ÇİFT	1/2 RAKORLU	53,00 €
TRPT2-231-8-150-1/2	2xPT-100	8	150	ÇİFT	1/2 RAKORLU	53,00 €
TRPT2-231-8-200-1/2	2xPT-100	8	200	ÇİFT	1/2 RAKORLU	55,00 €
TRPT2-231-8-250-1/2	2xPT-100	8	250	ÇİFT	1/2 RAKORLU	57,00 €
TRPT2-231-8-300-1/2	2xPT-100	8	300	ÇİFT	1/2 RAKORLU	59,00 €



## Nici-Ni'ler

- Düşük Fiyat, Yüksek Verimlilik ve Hassas Ölçüm
- Ölçüm Sıcaklık Aralığı 0-1200 °C'dir.
- Standart Dış Ölçüsü 1/2 Rakorludur.
- Standart Haricinde İstenilen Çap ve Boylarda Üretimi Yapılmaktadır.



Ürün Kodu	Eleman Cinsi	Boru Çapı (mm)	Dalma Boyu (mm)	Eleman Sayısı	Montaj Şekli	Fiyat
TCNK-231-6-50-1/2	Nici-Ni	6	50	TEK	1/2 RAKORLU	35,00 €
TCNK-231-6-100-1/2	Nici-Ni	6	100	TEK	1/2 RAKORLU	35,00 €
TCNK-231-6-150-1/2	Nici-Ni	6	150	TEK	1/2 RAKORLU	36,00 €
TCNK-231-6-200-1/2	Nici-Ni	6	200	TEK	1/2 RAKORLU	36,00 €
TCNK-231-6-250-1/2	Nici-Ni	6	250	TEK	1/2 RAKORLU	38,00 €
TCNK-231-6-300-1/2	Nici-Ni	6	300	TEK	1/2 RAKORLU	40,00 €
TCNK-231-6-350-1/2	Nici-Ni	6	350	TEK	1/2 RAKORLU	42,00 €
TCNK-231-6-400-1/2	Nici-Ni	6	400	TEK	1/2 RAKORLU	44,00 €
TCNK-231-6-450-1/2	Nici-Ni	6	450	TEK	1/2 RAKORLU	46,00 €
TCNK-231-6-500-1/2	Nici-Ni	6	500	TEK	1/2 RAKORLU	48,00 €
TCNK-231-8-50-1/2	Nici-Ni	8	50	TEK	1/2 RAKORLU	35,00 €
TCNK-231-8-100-1/2	Nici-Ni	8	100	TEK	1/2 RAKORLU	35,00 €
TCNK-231-8-150-1/2	Nici-Ni	8	150	TEK	1/2 RAKORLU	36,00 €
TCNK-231-8-200-1/2	Nici-Ni	8	200	TEK	1/2 RAKORLU	36,00 €
TCNK-231-8-250-1/2	Nici-Ni	8	250	TEK	1/2 RAKORLU	38,00 €
TCNK-231-8-300-1/2	Nici-Ni	8	300	TEK	1/2 RAKORLU	40,00 €
TCNK-231-8-350-1/2	Nici-Ni	8	350	TEK	1/2 RAKORLU	42,00 €
TCNK-231-8-400-1/2	Nici-Ni	8	400	TEK	1/2 RAKORLU	44,00 €
TCNK-231-8-450-1/2	Nici-Ni	8	450	TEK	1/2 RAKORLU	46,00 €
TCNK-231-8-500-1/2	Nici-Ni	8	500	TEK	1/2 RAKORLU	48,00 €
ITCNK-131-16-100	Nici-Ni	16	100	TEK	Dişsiz	42,00 €
ITCNK-131-16-150	Nici-Ni	16	150	TEK	Dişsiz	44,00 €
ITCNK-131-16-200	Nici-Ni	16	200	TEK	Dişsiz	46,00 €
ITCNK131-16-250	Nici-Ni	16	250	TEK	Dişsiz	48,00 €
ITCNK-131-16-300	Nici-Ni	16	300	TEK	Dişsiz	50,00 €
ITCNK-131-16-350	Nici-Ni	16	350	TEK	Dişsiz	52,00 €
ITCNK-131-16-400	Nici-Ni	16	400	TEK	Dişsiz	54,00 €
ITCNK-131-16-450	Nici-Ni	16	450	TEK	Dişsiz	56,00 €
ITCNK-131-16-500	Nici-Ni	16	500	TEK	Dişsiz	58,00 €
ITCNK-131-22-300	Nici-Ni	22	300	TEK	Dişsiz	64,00 €
ITCNK-131-22-350	Nici-Ni	22	350	TEK	Dişsiz	66,00 €
ITCNK-131-22-400	Nici-Ni	22	400	TEK	Dişsiz	68,00 €
ITCNK-131-22-500	Nici-Ni	22	500	TEK	Dişsiz	70,00 €
ITCNK-131-22-600	Nici-Ni	22	600	TEK	Dişsiz	72,00 €
ITCNK-131-22-700	Nici-Ni	22	700	TEK	Dişsiz	74,00 €
ITCNK-131-22-800	Nici-Ni	22	800	TEK	Dişsiz	76,00 €

Ürün Kodu	Eleman Cinsi	Boru Çapı (mm)	Dalma Boyu (mm)	Kablo Boyu (mt)	Termokupl Tipi	Fiyat
ETB50MNT3-P-1Ç	PT-100	3	50	1	PT-100	45 €
ETB100MNT3-P-1Ç	PT-100	3	100	1	PT-100	45 €
ETB150MNT3-P-1Ç	PT-100	3	150	1	PT-100	45 €
ETB200MNT3-P-1Ç	PT-100	3	200	1	PT-100	45 €
ETB250MNT3-P-1Ç	PT-100	3	250	1	PT-100	47 €
ETB50MNT1-F-1Ç	J	1	50	1	Fe-Const	18 €
ETB100MNT1-F-1Ç	J	1	100	1	Fe-Const	18 €
ETB150MNT1-F-1Ç	J	1	150	1	Fe-Const	18 €
ETB200MNT1-F-1Ç	J	1	200	1	Fe-Const	18 €
ETB250MNT1-F-1Ç	J	1	250	1	Fe-Const	20 €
ETB50MNT1,5-F-1Ç	J	1,5	50	1	Fe-Const	20 €
ETB100MNT1,5-F-1Ç	J	1,5	100	1	Fe-Const	22 €
ETB150MNT1,5-F-1Ç	J	1,5	150	1	Fe-Const	22 €
ETB200MNT1,5-F-1Ç	J	1,5	200	1	Fe-Const	22 €
ETB250MNT1,5-F-1Ç	J	1,5	250	1	Fe-Const	24 €
ETB50MNT2-F-1Ç	J	2	50	1	Fe-Const	14 €
ETB100MNT2-F-1Ç	J	2	100	1	Fe-Const	14 €
ETB150MNT2-F-1Ç	J	2	150	1	Fe-Const	14 €
ETB200MNT2-F-1Ç	J	2	200	1	Fe-Const	14 €
ETB250MNT2-F-1Ç	J	2	250	1	Fe-Const	16 €
ETB50MNT3-F-1Ç	J	3	50	1	Fe-Const	14 €
ETB100MNT3-F-1Ç	J	3	100	1	Fe-Const	14 €
ETB150MNT3-F-1Ç	J	3	150	1	Fe-Const	14 €
ETB200MNT3-F-1Ç	J	3	200	1	Fe-Const	14 €
ETB250MNT3-F-1Ç	J	3	250	1	Fe-Const	16 €
ETB50MNT1-N-1Ç	K	1	50	1	NiCr-Ni	21 €
ETB100MNT1-N-1Ç	K	1	100	1	NiCr-Ni	21 €
ETB150MNT1-N-1Ç	K	1	150	1	NiCr-Ni	21 €
ETB200MNT1-N-1Ç	K	1	200	1	NiCr-Ni	21 €
ETB250MNT1-N-1Ç	K	1	250	1	NiCr-Ni	24 €
ETB50MNT1,5-N-1Ç	K	1,5	50	1	NiCr-Ni	22 €
ETB100MNT1,5-N-1Ç	K	1,5	100	1	NiCr-Ni	22 €
ETB150MNT1,5-N-1Ç	K	1,5	150	1	NiCr-Ni	22 €
ETB200MNT1,5-N-1Ç	K	1,5	200	1	NiCr-Ni	22 €
ETB250MNT1,5-N-1Ç	K	1,5	250	1	NiCr-Ni	24 €
ETB50MNT2-N-1Ç	K	2	50	1	NiCr-Ni	22 €
ETB100MNT2-N-1Ç	K	2	100	1	NiCr-Ni	22 €
ETB150MNT2-N-1Ç	K	2	150	1	NiCr-Ni	22 €
ETB200MNT2-N-1Ç	K	2	200	1	NiCr-Ni	22 €
ETB250MNT2-N-1Ç	K	2	250	1	NiCr-Ni	24 €
ETB50MNT3-N-1Ç	K	3	50	1	NiCr-Ni	22 €
ETB100MNT3-N-1Ç	K	3	100	1	NiCr-Ni	22 €
ETB150MNT3-N-1Ç	K	3	150	1	NiCr-Ni	22 €
ETB200MNT3-N-1Ç	K	3	200	1	NiCr-Ni	22 €
ETB250MNT3-N-1Ç	K	3	250	1	NiCr-Ni	24 €
ETB300MNT3-N-1Ç	K	3	300	1	NiCr Ni	25 €



## Fe-Const'lar, PT-100'ler, Nicr-Ni'ler

- Düşük Fiyat ve Yüksek Güvenirlik
- Yüksek Verimlilik ve Hassas Ölçüm



Ürün Kodu	Eleman Cinsi	Boru Çapı (mm)	Dalma Boyu (mm)	Eleman Sayısı	Montaj Şekli	Fiyat
ETB-SKP6-1Ç	J			TEK	SKP6	4,50 €
ETB-SKP10-1Ç	J			TEK	SKP10	4,50 €
ETB-SKP16-1Ç	J			TEK	SKP16	4,50 €
ETB-MNF-F-1Ç	J			TEK	KARE MANİFOLT	7,50 €
ETB-M6-F-1Ç	J			TEK	M6 DIŞLI MANİFOLT	6,50 €
ETB-M8-F-1Ç	J			TEK	M8 DIŞLI MANİFOLT	6,50 €
ETB-MNF-P-1Ç	PT-100			TEK	KARE MANİFOLT	14 €
ETB-M6-P-1Ç	PT-100			TEK	M6 DIŞLI MANİFOLT	14 €
ETB-M8-P-1Ç	PT-100			TEK	M8 DIŞLI MANİFOLT	14 €
ETB-MNF-K-1Ç	NiCr-Ni			TEK	KARE MANİFOLT	12,50 €
ETB-M6-K-1Ç	NiCr-Ni			TEK	M6 DIŞLI MANİFOLT	11,50 €
ETB-M8-K-1Ç	NiCr-Ni			TEK	M8 DIŞLI MANİFOLT	11,50 €
ETB100-F04-1Ç	J	4	100	TEK	ÖZEL TİP	12 €
ETB100-F06-1Ç	J	6	100	TEK	ÖZEL TİP	12 €
ETB100-P06-1Ç	PT-100	6	100	TEK	ÖZEL TİP	19 €
ETB100-N06-1Ç	NiCr-Ni	6	100	TEK	ÖZEL TİP	15 €
ETB100-F08-1Ç	J	8	100	TEK	ÖZEL TİP	12 €
ETB100-P08-1Ç	PT-100	8	100	TEK	ÖZEL TİP	19 €
ETB100-N08-1Ç	NiCr-Ni	8	100	TEK	ÖZEL TİP	15 €
ETB100-F06-1Ç-1/2	J	6	100	TEK	1/2 RAKORLU ÖZEL TER.	19,50 €

## Özel Tip Termokupllar ve Termokupl Kabloları

- Termokupl ile Cihazlar Arasında Bağlantı Sağlar.



Ürün Kodu	Cinsi	Tipi	Fiyat
2*0,22	Fe-Const (J Type)	Slikon + Cam elyaf + Çelik blendajlı	2,40 €
2*0,75	Fe-Const (J Type)	Slikon + Cam elyaf + Çelik blendajlı	3,50 €
2*1,5	Fe-Const (J Type)	Slikon + Cam elyaf + Çelik blendajlı	4,00 €
2*0,22	PT-100	Slikon + Cam elyaf + Çelik blendajlı	2,40 €
3*0,22	PT-100	Slikon + Cam elyaf + Çelik blendajlı	3,00 €
4*0,22	PT-100	Slikon + Cam elyaf + Çelik blendajlı	4,00 €
2*0,22	NiCr-Ni (K Type)	Slikon + Cam elyaf + Çelik blendajlı	3,00 €
2*0,75	NiCr-Ni (K Type)	Slikon + Cam elyaf + Çelik blendajlı	3,50 €
2*1,5	NiCr-Ni (K Type)	Slikon + Cam elyaf + Çelik blendajlı	4,50 €

- Not: ▪ Fiyatı yazılmayan, diğer bayonet ve kafalı tip özel termokupl siparişleriniz için fiyat sorunuz.  
 ▪ Üretilen tüm çeşit termokupllar için değişik izolasyonlarda kompanzasyon kabloları temin edilir.



ISISO ENDÜSTRİYEL OTOMASYON ÜRÜNLERİ

# El Tipi Ölçü Aletleri, Termokupl Analog Çeviriciler, Isı Propları, Termokupl Soketleri

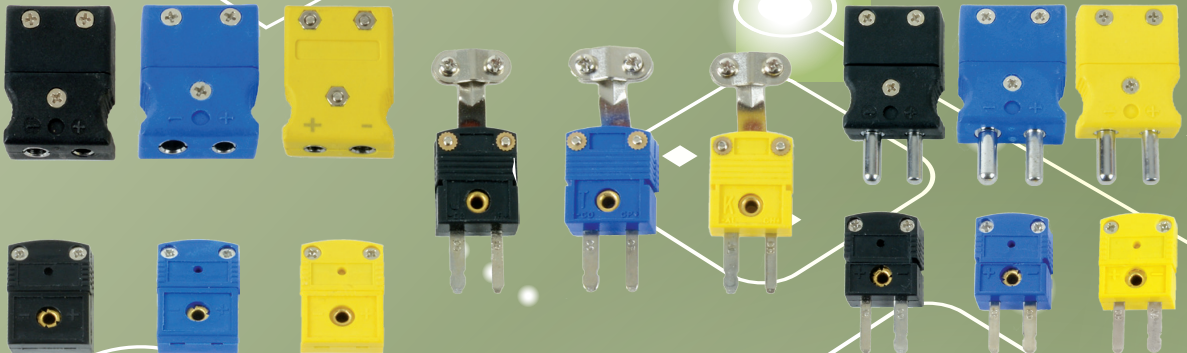



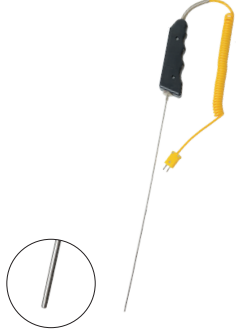

WRNM-102A



WRNM-01



WRNM-02



WRNM-101

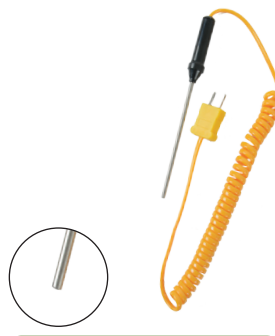

WRNM-207S

WRNM-J102 (NiCr-Ni)  
WZP-J102 (PT100)

WRN-01A



WRN-02B

Ürün Kodu	Eleman Cinsi	Ölçüm Sıcaklık Aralığı	Termokupl Tipi	Fiyat
WRNM-102A	K	-50 / +1100 °C	NiCr-Ni	24 \$
WRNM-01	K	-50 / +1100 °C	NiCr-Ni	24 \$
WRNM-02	K	-50 / +1100 °C	NiCr-Ni	24 \$
WRNM-101	K	-50 / +1100 °C	NiCr-Ni	39 \$
WRNM-207S	K	-50 / +1100 °C	NiCr-Ni	26 \$
WRNM-J102	K	-50 / +1100 °C	NiCr-Ni	24 \$
WZP-J102	PT100	-50 / +600 °C	PT-100	24 \$
WRN-02B	K	-50 / +1100 °C	NiCr-Ni	4 \$
WRN-01A	K	-50 / +1100 °C	NiCr-Ni	4 \$

## Termokupl Analog Çeviriciler



Kafa İçi



Ray Tipi



D148 Kablo

Ürün Kodu	Ürün Açıklaması	Giriş	Çıkış	Scale	Fiyat
D148	Kafa İçi Converter	PT-100 / PT1000 J Tipi / K Tipi	4-20 mA	Ayarlanabilir	48 \$
D149	Ray Tipi Converter	PT-100 / PT1000 J Tipi / K Tipi	4-20 mA	Ayarlanabilir	68 \$
D148 Kablo		USB Programlama Kablosu			350 \$



CK-45-DİŞİ



CK-05-ERKEK

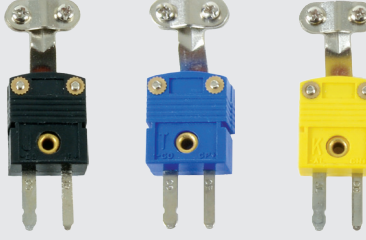

TC1-ERKEK



TC2-ERKEK



TC1-DİŞİ



TC2-DİŞİ

Ürün Kodu	Eleman Cinsi	Renk	Termokupl Tipi	Fiyat
CK-45SY-Dişi	J	Siyah	Fe-Const	8 €
CK-45SR-Dişi	K	Sarı	NiCr-Ni	8 €
CK-45MV-Dişi	-	-	-	8 €
CK-05SY-Erkek	J	Siyah	Fe-Const	8 €
CK-05SR-Erkek	K	Sarı	NiCr-Ni	8 €
CK-05MV-Erkek	-	-	-	8 €
TC1-SY-Erkek	J	Siyah	Fe-Const	6 €
TC1-SR-Erkek	K	Sarı	NiCr-Ni	6 €
TC1-MV-Erkek	-	-	-	6 €
TC1-SY-Dişi	J	Siyah	Fe-Const	5,50 €
TC1-SR-Dişi	K	Sarı	NiCr-Ni	5,50 €
TC1-MV-Dişi	-	-	-	5,50 €
TC2-SY-Erkek	J	Siyah	Fe-Const	5,50 €
TC2-SR-Erkek	K	Sarı	NiCr-Ni	5,50 €
TC2-MV-Erkek	-	-	-	5,50 €
TC2-SY-Dişi	J	Siyah	Fe-Const	5,50 €
TC2-SR-Dişi	K	Sarı	NiCr-Ni	5,50 €
TC2-MV-Dişi	-	-	-	5,50 €

**YENİ  
ÜRÜN**

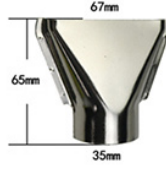
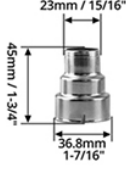

## Isı Ayarlı Sıcak Hava Tabancası

Ürün Kodu	Ürün Açıklaması	Fiyat
QR-332	Sıcak Hava Tabancası	46 \$
Güç	2000 W	
Ölçüler	53,5 x 47 x 53,5 cm	
Sıcaklık	60° - 600°	
Seçenek	6 farklı sıcaklık kademesi	

## Lazer & Temaslı Tip El Takometreleri

Ürün Kodu	Ürün Açıklaması	Fiyat
DT2236B	Lazer ve Temaslı Tip El Takometresi	58 \$
Model	DT2236B	
Dönüş Hızı	DT2234=2.5-99.999 RPM / DT2235=0.5-19.999 RPM	
Çözünürlük	1r/min (100 Rpm Üzeri)	
Doğuluk	±(0.059n+1) derece	
Örnekleme Zamanı	1.0 saniye (60 Rpm Üzeri)	



## El Tipi Lazer Termometre

Ürün Kodu	Ürün Açıklaması	Fiyat
SM-580	Lazer Tip El Termometresi	30 \$
Model	SM-580	
Sıcaklık Aralığı	-32 / 580 °C	
Ölçüm Hassaslığı	±2 °C	
Tekrar Hassasiyeti	±1 °C	
Ölçüm Mesafe Oranı	12:1	
Başlama Oranı	0.95	



SM-580

## El Tipi Termometre

Ürün Kodu	Ürün Açıklaması	Fiyat
TM-1310	El Tipi Termometre	50 \$
Model	TM-1310	
Ölçüm Aralığı	-50 / +1300 °C	
Ölçüm Hassasiyeti	0.1 °C	
Giriş Tipi	K (NiCr-Ni)	



TM-1310

# ISISO®

ISISO ENDÜSTRİYEL OTOMASYON ÜRÜNLERİ

Piston Sensörleri  
Işık Bariyerleri, Renk Fotoselleri, Reflektörler  
Fiber Optik Anfi & Kablolar, Konnektörlü Kablolar

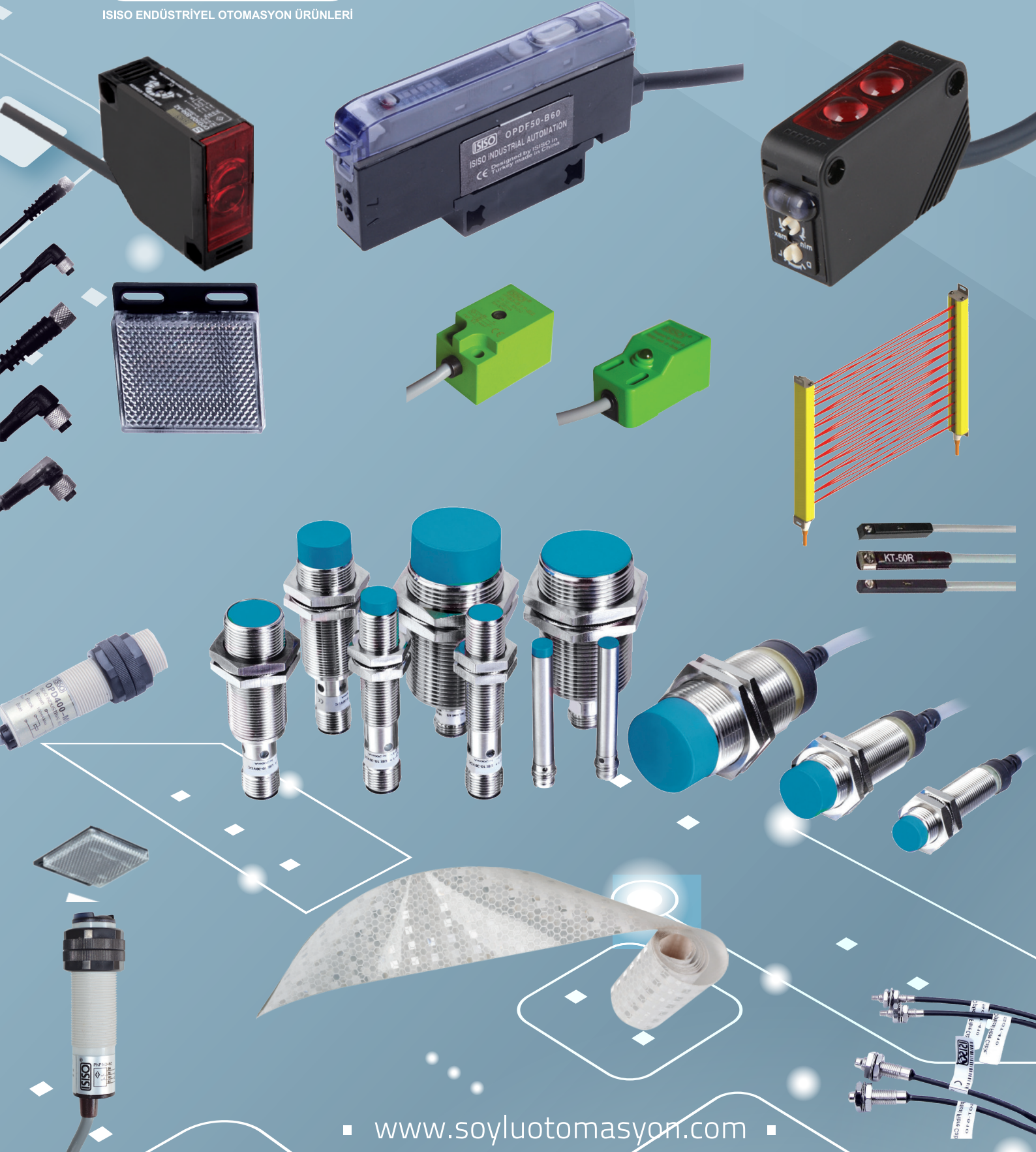

■ [www.soyluotomasyon.com](http://www.soyluotomasyon.com) ■



### M4-M5-M6.5-M8-M12 (Proximity) Sensörler



Çalışma Gerilimi 10-30 VDC,  
Pirinç - Nikel Kaplamalı Aşırı Yük  
Kısa Devre ve Ters Polarite Korumalı  
-25-+70C Çalışma Sıcaklığı  
IP67 Koruma Sınıfı  
Yük Akımı 100mA



Çalışma Gerilimi 10-30 VDC,  
Pirinç - Nikel Kaplamalı Aşırı Yük  
Kısa Devre ve Ters Polarite Korumalı  
-25-+70C Çalışma Sıcaklığı  
IP67 Koruma Sınıfı  
Yük Akımı 100mA



Çalışma Gerilimi 10-30 VDC ve 90-230 VAC'dir  
Pirinç - Nikel Kaplamalı Aşırı Yük  
Kısa Devre ve Ters Polarite Korumalı  
-25-+70C Çalışma Sıcaklığı  
IP67 Koruma Sınıfı  
Yük Akımı 100mA

Gövde Çapı	Bağlantı	Algılama Mesafesi	Kafa Tipi	Besleme	Çıkış	Kodu	Fiyat
M4	KABLO	0.8 mm	DÜZ	10-30 VDC	NPN NO	IMB0.8-T4-E0	30,00 \$
M4	KABLO	0.8 mm	DÜZ	10-30 VDC	PNP NO	IMB0.8-T4-E2	30,00 \$
M5	KABLO	0.8 mm	DÜZ	10-30 VDC	NPN NO	IMB0.8-M5-E0	23,00 \$
M5	KABLO	0.8 mm	DÜZ	10-30 VDC	PNP NO	IMB0.8-M5-E2	23,00 \$
M6.5	KABLO	1.5 mm	DÜZ	10-30 VDC	NPN NO	IMB1.5-T6.5-E0	16,50 \$
M6.5	KABLO	1.5 mm	DÜZ	10-30 VDC	PNP NO	IMB1.5-T6.5-E2	16,50 \$

Gövde Çapı	Bağlantı	Algılama Mesafesi	Kafa Tipi	Besleme	Çıkış	Kodu	Fiyat
M8	KABLO	2 mm	DÜZ	10-30 VDC	NPN NO	IMB2-M8-E0	25,50 \$
M8	KABLO	2 mm	DÜZ	10-30 VDC	NPN NC	IMB2-M8-E1	25,50 \$
M8	KABLO	2 mm	DÜZ	10-30 VDC	PNP NO	IMB2-M8-E2	25,50 \$
M8	KABLO	2 mm	DÜZ	10-30 VDC	PNP NC	IMB2-M8-E3	25,50 \$
M8	M12 KONNT.	2 mm	DÜZ	10-30 VDC	NPN NO	IMB2-M8-E0C	26,00 \$
M8	M12 KONNT.	2 mm	DÜZ	10-30 VDC	PNP NO	IMB2-M8-E2C	26,00 \$
M8	M8 KONNT.	2 mm	DÜZ	10-30 VDC	PNP NO	IMB2-M8-E2C8	26,00 \$
M8	M8 KONNT.	2 mm	DÜZ	10-30 VDC	NPN NO	IMB2-M8-E0C8	26,00 \$
M8	KABLO	3 mm	ÇIKIK	10-30 VDC	NPN NO	IMN3-M8-E0	25,50 \$
M8	KABLO	3 mm	ÇIKIK	10-30 VDC	NPN NC	IMN3-M8-E1	25,50 \$
M8	KABLO	3 mm	ÇIKIK	10-30 VDC	PNP NO	IMN3-M8-E2	25,50 \$
M8	KABLO	3 mm	ÇIKIK	10-30 VDC	PNP NC	IMN3-M8-E3	25,50 \$
M8	M8 KONNT.	3 mm	ÇIKIK	10-30 VDC	NPN NO	IMN3-M8-E0C8	26,00 \$
M8	M8 KONNT.	3 mm	ÇIKIK	10-30 VDC	PNP NO	IMN3-M8-E2C8	26,00 \$
M8	M12 KONNT.	3 mm	ÇIKIK	10-30 VDC	NPN NO	IMN3-M8-E0C	26,00 \$
M8	M12 KONNT.	3 mm	ÇIKIK	10-30 VDC	PNP NO	IMN3-M8-E2C	26,00 \$

Gövde Çapı	Bağlantı	Algılama Mesafesi	Kafa Tipi	Besleme	Çıkış	Kodu	Fiyat
M12	KABLO	4 mm	DÜZ	10-30 VDC	NPN NO	IMB4-M12-E0	13,00 \$
M12	KABLO	4 mm	DÜZ	10-30 VDC	NPN NC	IMB4-M12-E1	13,00 \$
M12	KABLO	4 mm	DÜZ	10-30 VDC	PNP NO	IMB4-M12-E2	13,00 \$
M12	KABLO	4 mm	DÜZ	10-30 VDC	PNP NC	IMB4-M12-E3	13,00 \$
M12	M12 KON.	4 mm	DÜZ	10-30 VDC	NPN NO	IMB4-M12-E0C	15,00 \$
M12	M12 KON.	4 mm	DÜZ	10-30 VDC	NPN NC	IMB4-M12-E1C	15,00 \$
M12	M12 KON.	4 mm	DÜZ	10-30 VDC	PNP NO	IMB4-M12-E2C	15,00 \$
M12	M12 KON.	4 mm	DÜZ	10-30 VDC	PNP NC	IMB4-M12-E3C	15,00 \$
M12	KABLO	6 mm	ÇIKIK	10-30 VDC	NPN NO	IMN6-M12-E0	20,00 \$
M12	KABLO	6 mm	ÇIKIK	10-30 VDC	NPN NC	IMN6-M12-E1	20,00 \$
M12	KABLO	6 mm	ÇIKIK	10-30 VDC	PNP NO	IMN6-M12-E2	20,00 \$
M12	KABLO	6 mm	ÇIKIK	10-30 VDC	PNP NC	IMN6-M12-E3	20,00 \$
M12	M12 KON.	6 mm	ÇIKIK	10-30 VDC	NPN NO	IMN6-M12-E0C	22,00 \$
M12	M12 KON.	6 mm	ÇIKIK	10-30 VDC	NPN NC	IMN6-M12-E1C	22,00 \$
M12	M12 KON.	6 mm	ÇIKIK	10-30 VDC	PNP NO	IMN6-M12-E2C	22,00 \$
M12	M12 KON.	6 mm	ÇIKIK	10-30 VDC	PNP NC	IMN6-M12-E3C	22,00 \$
M12	KABLO	4 mm	DÜZ	10-30 VDC	NPN NO+NC	IMB4-M12-A0	25,00 \$
M12	KABLO	4 mm	DÜZ	10-30 VDC	PNP NO+NC	IMB4-M12-A2	25,00 \$
M12	KABLO	6 mm	ÇIKIK	10-30 VDC	NPN NO+NC	IMN6-M12-A0	25,00 \$
M12	KABLO	6 mm	ÇIKIK	10-30 VDC	PNP NO+NC	IMN6-M12-A2	25,00 \$
M12	KABLO	4 mm	DÜZ	90-250 VAC	NO	IMB4-M12-W0	25,00 \$
M12	KABLO	4 mm	DÜZ	90-250 VAC	NC	IMB4-M12-W5	26,00 \$
M12	KABLO	6 mm	ÇIKIK	90-250 VAC	NO	IMN6-M12-W0	25,00 \$
M12	KABLO	6 mm	ÇIKIK	90-250 VAC	NC	IMN6-M12-W5	26,00 \$



## Genişletilmiş Algılama

### M18-M30 (Proximity) Sensörler

Gövde Çapı	Bağlantı	Algılama Mesafesi	Kafa Tipi	Besleme	Çıkış	Kodu	Fiyat
M 18	KABLO	8 mm	DÜZ	10-30 VDC	NPN NO	IMB8-M18-E0	16,50 \$
M 18	KABLO	8 mm	DÜZ	10-30 VDC	NPN NC	IMB8-M18-E1	16,50 \$
M 18	KABLO	8 mm	DÜZ	10-30 VDC	PNP NO	IMB8-M18-E2	16,50 \$
M 18	KABLO	8 mm	DÜZ	10-30 VDC	PNP NC	IMB8-M18-E3	16,50 \$
M 18	M12 KON.	8 mm	DÜZ	10-30 VDC	NPN NO	IMB8-M18-E0C	20,00 \$
M 18	M12 KON.	8 mm	DÜZ	10-30 VDC	NPN NC	IMB8-M18-E1C	20,00 \$
M 18	M12 KON.	8 mm	DÜZ	10-30 VDC	PNP NO	IMB8-M18-E2C	20,00 \$
M 18	M12 KON.	8 mm	DÜZ	10-30 VDC	PNP NC	IMB8-M18-E3C	20,00 \$
M 18	KABLO	12 mm	ÇIKIK	10-30 VDC	NPN NO	IMN12-M18-E0	25,00 \$
M 18	KABLO	12 mm	ÇIKIK	10-30 VDC	NPN NC	IMN12-M18-E1	25,00 \$
M 18	KABLO	12 mm	ÇIKIK	10-30 VDC	PNP NO	IMN12-M18-E2	25,00 \$
M 18	KABLO	12 mm	ÇIKIK	10-30 VDC	PNP NC	IMN12-M18-E3	25,00 \$
M 18	M12 KON.	12 mm	ÇIKIK	10-30 VDC	NPN NO	IMN12-M18-E0C	28,00 \$
M 18	M12 KON.	12 mm	ÇIKIK	10-30 VDC	NPN NC	IMN12-M18-E1C	28,00 \$
M 18	M12 KON.	12 mm	ÇIKIK	10-30 VDC	PNP NO	IMN12-M18-E2C	28,00 \$
M 18	M12 KON.	12 mm	ÇIKIK	10-30 VDC	PNP NC	IMN12-M18-E3C	28,00 \$
M 18	KABLO	8 mm	DÜZ	10-30 VDC	NPN NO+NC	IMB8-M18-A0	27,00 \$
M 18	KABLO	8 mm	DÜZ	10-30 VDC	PNP NO+NC	IMB8-M18-A2	27,00 \$
M 18	KABLO	12 mm	ÇIKIK	10-30 VDC	NPN NO+NC	IMN12-M18-A0	29,00 \$
M 18	KABLO	12 mm	ÇIKIK	10-30 VDC	PNP NO+NC	IMN12-M18-A2	29,00 \$
M 18	KABLO	8 mm	DÜZ	<b>90-250 VAC</b>	NO	IMB8-M18-W0	23,00 \$
M 18	KABLO	8 mm	DÜZ	<b>90-250 VAC</b>	NC	IMB8-M18-WS	24,00 \$
M 18	KABLO	12 mm	ÇIKIK	<b>90-250 VAC</b>	NO	IMN12-M18-W0	25,00 \$
M 18	KABLO	12 mm	ÇIKIK	<b>90-250 VAC</b>	NC	IMN12-M18-WS	26,00 \$



Çalışma Gerilimi 10-30 VDC ve 90-230 VAC'dir  
Pirinç - Nikel Kaplamalı Aşırı Yük  
Kısa Devre ve Ters Polarite Korumalı  
-25-+70C Çalışma Sıcaklığı  
IP67 Koruma Sınıfı  
Yük Akımı 100mA

Gövde Çapı	Bağlantı	Algılama Mesafesi	Kafa Tipi	Besleme	Çıkış	Kodu	Fiyat
M 30	M12 KON.	10 mm	DÜZ	10-30 VDC	NPN NO	IMB10-M30-E0C	26,00 \$
M 30	M12 KON.	10 mm	DÜZ	10-30 VDC	NPN NC	IMB10-M30-E1C	26,00 \$
M 30	M12 KON.	10 mm	DÜZ	10-30 VDC	PNP NO	IMB10-M30-E2C	26,00 \$
M 30	M12 KON.	10 mm	DÜZ	10-30 VDC	PNP NC	IMB10-M30-E3C	26,00 \$
M 30	M12 KON.	15 mm	ÇIKIK	10-30 VDC	NPN NO	IMN15-M30-E0C	26,00 \$
M 30	M12 KON.	15 mm	ÇIKIK	10-30 VDC	NPN NC	IMN15-M30-E1C	26,00 \$
M 30	M12 KON.	15 mm	ÇIKIK	10-30 VDC	PNP NO	IMN15-M30-E2C	26,00 \$
M 30	M12 KON.	15 mm	ÇIKIK	10-30 VDC	PNP NC	IMN15-M30-E3C	26,00 \$
M 30	KABLO	10 mm	DÜZ	10-30 VDC	NPN NO+NC	IMB10-M30-A0	32,00 \$
M 30	KABLO	10 mm	DÜZ	10-30 VDC	PNP NO+NC	IMB10-M30-A2	32,00 \$
M 30	KABLO	15 mm	ÇIKIK	10-30 VDC	NPN NO+NC	IMN15-M30-A0	32,00 \$
M 30	KABLO	15 mm	ÇIKIK	10-30 VDC	PNP NO+NC	IMN15-M30-A2	32,00 \$
M 30	KABLO	10 mm	DÜZ	<b>90-250 VAC</b>	NO	IMB10-M30-W0	29,00 \$
M 30	KABLO	10 mm	DÜZ	<b>90-250 VAC</b>	NC	IMB10-M30-WS	30,00 \$
M 30	KABLO	15 mm	ÇIKIK	<b>90-250 VAC</b>	NO	IMN15-M30-W0	29,00 \$
M 30	KABLO	15 mm	ÇIKIK	<b>90-250 VAC</b>	NC	IMN15-M30-WS	30,00 \$



Çalışma Gerilimi 10-30 VDC ve 90-230 VAC'dir  
Pirinç - Nikel Kaplamalı Aşırı Yük  
Kısa Devre ve Ters Polarite Korumalı  
-25-+70C Çalışma Sıcaklığı  
IP67 Koruma Sınıfı  
Yük Akımı 100mA

## Küçük Tip İNDÜKTİF Sensörler

■ Çalışma Gerilimi 10-30 VDC ve 90-250 VAC'dir. Pirinç - Nikel Kaplamalı Aşırı Yük, Kısa Devre ve Ters Polarite Korumalı -25- +70 C Çalışma Sıcaklığı IP67 Koruma Sınıfı, Yük Akımı 100mA

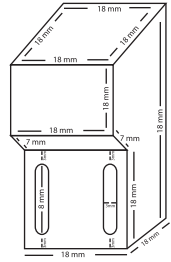
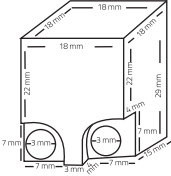
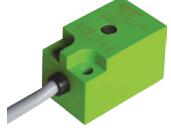

Gövde Çapı	Bağlantı	Algılama Mesafesi	Kafa Tipi	Besleme	Çıkış	Kodu	Fiyat
KÜBİK	KABLO	5 mm	DÜZ	10-30 VDC	NPN NO	IPB5-B17-E0	12,00 \$
KÜBİK	KABLO	5 mm	DÜZ	10-30 VDC	NPN NC	IPB5-B17-E1	12,00 \$
KÜBİK	KABLO	5 mm	DÜZ	10-30 VDC	PNP NO	IPB5-B17-E2	12,00 \$
KÜBİK	KABLO	5 mm	DÜZ	10-30 VDC	PNP NC	IPB5-B17-E3	12,00 \$
KÜBİK	KABLO	8 mm	DÜZ	10-30 VDC	NPN NO	IPN8-B17-E0	12,00 \$
KÜBİK	KABLO	8 mm	DÜZ	10-30 VDC	NPN NC	IPN8-B17-E1	12,00 \$
KÜBİK	KABLO	8 mm	DÜZ	10-30 VDC	PNP NO	IPN8-B17-E2	12,00 \$
KÜBİK	KABLO	8 mm	DÜZ	10-30 VDC	PNP NC	IPN8-B17-E3	12,00 \$
KÜBİK	KABLO	5 mm	DÜZ	10-30 VDC	NPN NO	IPB5-B18-E0	12,50 \$
KÜBİK	KABLO	5 mm	DÜZ	10-30 VDC	NPN NC	IPB5-B18-E1	12,50 \$
KÜBİK	KABLO	5 mm	DÜZ	10-30 VDC	PNP NO	IPB5-B18-E2	12,50 \$
KÜBİK	KABLO	5 mm	DÜZ	10-30 VDC	PNP NC	IPB5-B18-E3	12,50 \$
KÜBİK	KABLO	8 mm	DÜZ	10-30 VDC	NPN NO	IPN8-B18-E0	12,50 \$
KÜBİK	KABLO	8 mm	DÜZ	10-30 VDC	NPN NC	IPN8-B18-E1	12,50 \$
KÜBİK	KABLO	8 mm	DÜZ	10-30 VDC	PNP NO	IPN8-B18-E2	12,50 \$
KÜBİK	KABLO	8 mm	DÜZ	10-30 VDC	PNP NC	IPN8-B18-E3	12,50 \$

## Kapasitif Sensörler

■ Çalışma Gerilimi 10-30 VDC, Pirinç - Nikel Kaplamalı Aşırı Yük, Kısa Devre ve Ters Polarite Korumalı -25- +70 C Çalışma Sıcaklığı IP67 Koruma Sınıfı, Yük Akımı 100mA



Gövde Çapı	Bağlantı	Algılama Mesafesi	Kafa Tipi	Besleme	Çıkış	Kodu	Fiyat
M 18	KABLO	5 mm	DÜZ	10-30 VDC	NPN NO+NC	CPB5-M18-A0	38,00 \$
M 18	KABLO	5 mm	DÜZ	10-30 VDC	PNP NO+NC	CPB5-M18-A2	38,00 \$
M 18	KABLO	8 mm	ÇIKIK	10-30 VDC	NPN NO+NC	CPN8-M18-A0	38,00 \$
M 18	KABLO	8 mm	ÇIKIK	10-30 VDC	PNP NO+NC	CPN8-M18-A2	38,00 \$
M 18	KABLO	5 mm	DÜZ	<b>20-250 VAC</b>	NO	CPB5-M18-W0	40,00 \$
M 18	KABLO	5 mm	DÜZ	<b>20-250 VAC</b>	NC	CPB5-M18-WS	40,00 \$
M 18	KABLO	8 mm	ÇIKIK	<b>20-250 VAC</b>	NO	CPN8-M18-W0	40,00 \$
M 18	KABLO	8 mm	ÇIKIK	<b>20-250 VAC</b>	NC	CPN8-M18-WS	40,00 \$
M 30	KABLO	10 mm	DÜZ	10-30 VDC	NPN NO+NC	CPB10-M30-A0	34,00 \$
M 30	KABLO	10 mm	DÜZ	10-30 VDC	PNP NO+NC	CPB10-M30-A2	34,00 \$
M 30	KABLO	15 mm	ÇIKIK	10-30 VDC	NPN NO+NC	CPN15-M30-A0	34,00 \$
M 30	KABLO	15 mm	ÇIKIK	10-30 VDC	PNP NO+NC	CPN15-M30-A2	34,00 \$
M 30	KABLO	10 mm	DÜZ	<b>20-250 VAC</b>	NO	CPB10-M30-W0	42,00 \$
M 30	KABLO	10 mm	DÜZ	<b>20-250 VAC</b>	NC	CPB10-M30-WS	42,00 \$
M 30	KABLO	15 mm	ÇIKIK	<b>20-250 VAC</b>	NO	CPN15-M30-W0	42,00 \$
M 30	KABLO	15 mm	ÇIKIK	<b>20-250 VAC</b>	NC	CPN15-M30-WS	42,00 \$

### Cisimden Yansımali

Gövde Çapı	Bağlantı	Algılama Mesafesi	Kafa Tipi	Besleme	Çıkış	Kodu	Fiyat
KÜBİK	KABLO	30 cm	4 KABLOLU	10-30 VDC	NPN NO+NC	OPD300-B32-A0	53,00 \$
KÜBİK	KABLO	30 cm	4 KABLOLU	10-30 VDC	PNP NO+NC	OPD300-B32-A2	53,00 \$
KÜBİK	KABLO	80 cm	4 KABLOLU	10-30 VDC	NPN NO+NC	OPD800-B32-A0	55,00 \$
KÜBİK	KABLO	80 cm	4 KABLOLU	10-30 VDC	PNP NO+NC	OPD800-B32-A2	55,00 \$
KÜBİK	M8 KON.	80 cm	M8 KON.	10-30 VDC	NPN NO+NC	OPD800-B32-A0C8	57,00 \$
KÜBİK	M8 KON.	80 cm	M8 KON.	10-30 VDC	PNP NO+NC	OPD800-B32-A2C8	57,00 \$



### Reflektörlü

KÜBİK	KABLO	2 mt	4 KABLOLU	10-30 VDC	NPN NO+NC	OPR2000-B32-A0	53,00 \$
KÜBİK	KABLO	2 mt	4 KABLOLU	10-30 VDC	PNP NO+NC	OPR2000-B32-A2	53,00 \$

## B50 Serisi Prizmatik Fotoseller

### Cisimden Yansımali

Gövde Çapı	Bağlantı	Algılama Mesafesi	Kafa Tipi	Besleme	Çıkış	Kodu	Fiyat
KÜBİK	KABLO	50 cm	4 KABLOLU	10-30 VDC	NPN NO+NC	OPD500-B50-A0	41,00 \$
KÜBİK	KABLO	50 cm	4 KABLOLU	10-30 VDC	PNP NO+NC	OPD500-B50-A2	41,00 \$
KÜBİK	KABLO	200 cm	4 KABLOLU	10-30 VDC	NPN NO+NC	OPD2000-B50-A0	63,00 \$
KÜBİK	KABLO	200 cm	4 KABLOLU	10-30 VDC	PNP NO+NC	OPD2000-B50-A2	63,00 \$
KÜBİK	KABLO	50 cm	4 KABLOLU	12-240 VAC/DC	NO+NC	OPD500-B50-R0	48,00 \$

### Reflektörlü

KÜBİK	KABLO	5 mt	4 KABLOLU	10-30 VDC	NPN NO+NC	OPR5000-B50-A0	40,00 \$
KÜBİK	KABLO	5 mt	4 KABLOLU	10-30 VDC	PNP NO+NC	OPR5000-B50-A2	40,00 \$
KÜBİK	KABLO	5 mt	4 KABLOLU	12-240 VAC/DC	NO+NC	OPR5000-B50-R0	46,00 \$



## Renk Fotoselleri

Çalışma Gerilimi 10-30 VDC Aşırı Yük, Kısa Devre ve Ters Polarite Korumalı, -25- +70 C Çalışma Sıcaklığı, IP 67 Koruma Sınıfı, Yük Akımı 200 mA'dır.

Gövde Çapı	Bağlantı	Algılama Mesafesi	Kafa Tipi	Besleme	Çıkış	Kodu	Fiyat
B 80	KABLO	15 mm	4 UÇLU	10-30 VDC	NPN NO+NC	CMM15-B80-A0	90,00 \$
B 80	KABLO	15 mm	4 UÇLU	10-30 VDC	PNP NO+NC	CMM15-B80-A2	90,00 \$



## Cisimden Yansımali Fotoseller

■ Çalışma Gerilimi Silindirik Tiplerde 10-30 VDC ve 90-250 VAC, Kübik Tiplerde 10-30 VDC ve 12-240 VAC/DC'dir. Plastik ve Metal Gövdeli, Mesafe Ayarlı, Aşırı Yük, Kısa Devre ve Ters Polarite Korumalı, -25- +70 C Çalışma Sıcaklığı, IP 67 Koruma Sınıfı, Yük Akımı 200 mA'dır.



Gövde Çapı	Bağlantı	Algılama Mesafesi	Kafa Tipi	Besleme	Çıkış	Kodu	Fiyat
M 12	KABLO	10 cm	4 UÇLU	10-30 VDC	NPN NO+NC	OPD100-M12-A0	45,00 \$
M 12	KABLO	10 cm	4 UÇLU	10-30 VDC	PNP NO+NC	OPD100-M12-A2	45,00 \$
M 18	M12 KON.	10 cm	3 UÇLU	10-30 VDC	NPN NO	OPD100-M18-E0C	30,00 \$
M 18	M12 KON.	10 cm	3 UÇLU	10-30 VDC	NPN NC	OPD100-M18-E1C	30,00 \$
M 18	M12 KON.	10 cm	3 UÇLU	10-30 VDC	PNP NO	OPD100-M18-E2C	30,00 \$
M 18	M12 KON.	10 cm	3 UÇLU	10-30 VDC	PNP NC	OPD100-M18-E3C	30,00 \$
M 18	KABLO	10 cm	4 UÇLU	10-30 VDC	NPN NO+NC	OPD100-M18-A0	29,00 \$
M 18	KABLO	10 cm	4 UÇLU	10-30 VDC	PNP NO+NC	OPD100-M18-A2	29,00 \$
M 18	M12 KON.	40 cm	3 UÇLU	10-30 VDC	NPN NO	OPD400-M18-E0C	30,00 \$
M 18	M12 KON.	40 cm	3 UÇLU	10-30 VDC	NPN NC	OPD400-M18-E1C	30,00 \$
M 18	M12 KON.	40 cm	3 UÇLU	10-30 VDC	PNP NO	OPD400-M18-E2C	30,00 \$
M 18	M12 KON.	40 cm	3 UÇLU	10-30 VDC	PNP NC	OPD400-M18-E3C	30,00 \$
M 18	KABLO	40 cm	3 UÇLU	10-30 VDC	PNP NO	OPD400-M18-E2	25,00 \$
M 18	KABLO	40 cm	4 UÇLU	10-30 VDC	NPN NO+NC	OPD400-M18-A0	29,00 \$
M 18	KABLO	40 cm	4 UÇLU	10-30 VDC	PNP NO+NC	OPD400-M18-A2	29,00 \$
M 18	KABLO	40 cm	2 UÇLU	<b>90-250 VAC</b>	NO	OPD400-M18-WO	37,00 \$
M 18	KABLO	40 cm	2 UÇLU	<b>90-250 VAC</b>	NC	OPD400-M18-WS	37,00 \$
M 18	KABLO	80 cm	4 UÇLU	10-30 VDC	NPN NO+NC	OPD800-M18-A0	34,00 \$
M 18	KABLO	80 cm	4 UÇLU	10-30 VDC	PNP NO+NC	OPD800-M18-A2	34,00 \$
M 12	KABLO	10 cm	4 UÇLU	10-30 VDC	PNP NO+NC	OMD100-M12-A2	45,00 \$
M 12	KABLO	20 cm	4 UÇLU	10-30 VDC	PNP NO+NC	OMD200-M12-A2	45,00 \$

Metal Gövde

## Reflektörlü Fotoseller

■ Çalışma Gerilimi Silindirik Tiplerde 10-30 VDC ve 90-250 VAC, Kübik Tiplerde 10-30 VDC ve 12-240 VAC/DC'dir. Plastik ve Metal Gövdeli, Mesafe Ayarlı, Aşırı Yük, Kısa Devre ve Ters Polarite Korumalı, -25- +70 C Çalışma Sıcaklığı, IP 67 Koruma Sınıfı, Yük Akımı 200 mA'dır.

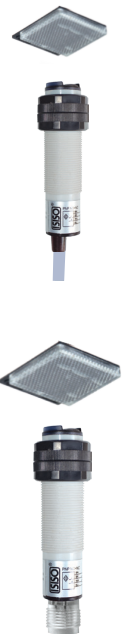

Gövde Çapı	Bağlantı	Algılama Mesafesi	Kafa Tipi	Besleme	Çıkış	Kodu	Fiyat
M 12	KABLO	3 mt	4 UÇLU	10-30 VDC	NPN NO+NC	OPR3000-M12-A0	40,00 \$
M 12	KABLO	3 mt	4 UÇLU	10-30 VDC	PNP NO+NC	OPR3000-M12-A2	40,00 \$
M 12	M12 KON.	3 mt	3 UÇLU	10-30 VDC	NPN NO	OPR3000-M12-E0C	43,00 \$
M 12	M12 KON.	3 mt	3 UÇLU	10-30 VDC	NPN NC	OPR3000-M12-E1C	43,00 \$
M 12	M12 KON.	3 mt	3 UÇLU	10-30 VDC	PNP NO	OPR3000-M12-E2C	43,00 \$
M 12	M12 KON.	3 mt	3 UÇLU	10-30 VDC	PNP NC	OPR3000-M12-E3C	43,00 \$
M 18	KABLO	4 mt	3 UÇLU	10-30 VDC	PNP NO	OPR4000-M18-E2	27,00 \$
M 18	KABLO	4 mt	4 UÇLU	10-30 VDC	NPN NO+NC	OPR4000-M18-A0	29,00 \$
M 18	KABLO	4 mt	4 UÇLU	10-30 VDC	PNP NO+NC	OPR4000-M18-A2	29,00 \$
M 18	M12 KON.	4 mt	3 UÇLU	10-30 VDC	NPN NO	OPR4000-M18-E0C	30,00 \$
M 18	M12 KON.	4 mt	3 UÇLU	10-30 VDC	NPN NC	OPR4000-M18-E1C	30,00 \$
M 18	M12 KON.	4 mt	3 UÇLU	10-30 VDC	PNP NO	OPR4000-M18-E2C	30,00 \$
M 18	M12 KON.	4 mt	3 UÇLU	10-30 VDC	PNP NC	OPR4000-M18-E3C	30,00 \$
M 18	KABLO	4 mt	2 UÇLU	<b>90-250 VAC</b>	NO	OPR4000-M18-WO	30,00 \$
M 18	KABLO	4 mt	2 UÇLU	<b>90-250 VAC</b>	NC	OPR4000-M18-WS	30,00 \$

## Piston Tip Manyetik Sensörler

■ Pirinç - Nikel Kaplamalı Aşırı Yük, Kısa Devre ve Ters Polarite Korumalı -25-+70 C Çalışma Sıcaklığı IP67 Koruma Sınıfı, Yük Akımı 100mA

Bağlantı	Boyutlar	Besleme	Çıkış	Kodu	Fiyat
2 Kablolu	25.5x4 mm	5-120 VDC-AC	NO	IKT-06R-2M	19,00 \$
2 Kablolu	30x6.3 mm	5-240 VDC-AC	NO	IKT-50R-2M	17,00 \$
2 Kablolu	25.5x4 mm	5-240 VDC-AC	NO	IKT-072R-3M	18,00 \$



## Işık Bariyerleri (İstenilen ölçü ve boyutlarda üretim yapılabilmektedir.)

Ürün Boyutu	Renk	Ölçü	Dahili Modül	Besleme	Çıkış	Kodu	Fiyat
250 x 20 x 29 cm	Sarı	25 cm	RS-485 ANALOG	24 VDC	PNP-NC	ISCB-GB12	300 \$
325 x 20 x 29 cm	Sarı	32 cm	RS-485 ANALOG	24 VDC	PNP-NC	ISCB-GB16	350 \$
500 x 20 x 29 cm	Sarı	50 cm	RS-485 ANALOG	24 VDC	PNP-NC	ISCB-GB24	600 \$
735 x 20 x 29 cm	Sarı	75 cm	RS-485 ANALOG	24 VDC	PNP-NC	ISCB-GB36	850 \$
980 x 20 x 29 cm	Sarı	1 Mt	RS-485 ANALOG	24 VDC	PNP-NC	ISCB-GB48	1.100 \$
1225 x 20 x 29 cm	Sarı	1,2 Mt	RS-485 ANALOG	24 VDC	PNP-NC	ISCB-GB60	1.400 \$
1470 x 20 x 29 cm	Sarı	1,5 Mt	RS-485 ANALOG	24 VDC	PNP-NC	ISCB-GB72	1.700 \$
1950 x 20 x 29 cm	Sarı	2 Mt	RS-485 ANALOG	24 VDC	PNP-NC	ISCB-GB96	2.200 \$
2430 x 20 x 29 cm	Sarı	2,4 Mt	RS-485 ANALOG	24 VDC	PNP-NC	ISCB-GB120	2.700 \$
2910 x 20 x 29 cm	Sarı	3 Mt	RS-485 ANALOG	24 VDC	PNP-NC	ISCB-GB144	3.260 \$

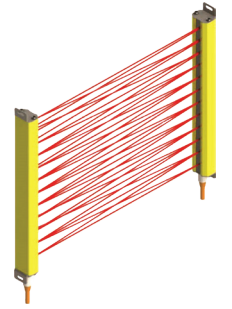





## Dijital Göstergeli FİBER OPTİK AMFİ ve Kabloları

Gövde Çapı	Bağlantı	Algılama Mesafesi	Kafa Tipi	Besleme	Çıkış	Kodu	Fiyat
B 60	KABLO	50 mm	3 UÇLU	10-30 VDC	NPN NO+NC	OP0F50-B60-A0	75,00 \$
B 60	KABLO	50 mm	3 UÇLU	10-30 VDC	PNP NO+NC	OP0F50-B60-A2	75,00 \$
M 4	Fiber Optik Kablo Cisimden Yansımali					SGT-410	21,00 \$
M 6	Fiber Optik Kablo Cisimden Yansımali					SGT-610	22,00 \$
M 4	Fiber Optik Kablo Karşılıklı					SGRS-410	23,00 \$
M 6	Fiber Optik Kablo Karşılıklı					SGRS-610	27,00 \$

## Konnektörlü Kablolar

Ölçü	Pin Sayısı	Model	Tipi	Kablo	Kodu	Fiyat
M 8	3	LEDSİZ	DÜZ	2 mt	C8-S3-2000	7,50 \$
M 8	3	LEDSİZ	DÜZ	5 mt	C8-S3-5000	12,00 \$
M 8	3	LEDSİZ	90 DERECE	2 mt	C8-L3-2000	7,50 \$
M 8	3	LEDSİZ	90 DERECE	5 mt	C8-L3-5000	12,00 \$
M 8	4	LEDSİZ	DÜZ	2 mt	C8-S4-2000	11,00 \$
M 8	4	LEDSİZ	DÜZ	5 mt	C8-S4-5000	15,00 \$
M 8	4	LEDSİZ	90 DERECE	2 mt	C8-L4-2000	11,00 \$
M 8	4	LEDSİZ	90 DERECE	5 mt	C8-L4-5000	15,00 \$
M 12	4	LEDSİZ	DÜZ	2 mt	C12-S4-2000	7,50 \$
M 12	4	LEDSİZ	DÜZ	5 mt	C12-S4-5000	10,50 \$
M 12	4	LEDSİZ	DÜZ	10 mt	C12-S4-10000	17 \$
M 12	4	LEDSİZ	90 DERECE	2 mt	C12-L4-2000	7,50 \$
M 12	4	LEDSİZ	90 DERECE	5 mt	C12-L4-5000	10,50 \$
M 12	4	LEDSİZ	90 DERECE	10 mt	C12-L4-10000	17 \$
M 12	4	LEDLİ	90 DERECE	2 mt	C12I-L4-2000	12,50 \$
M 12	4	LEDLİ	90 DERECE	5 mt	C12I-L4-5000	13,50 \$
M 12	5	LEDSİZ	DÜZ	2 mt	C12-S5-2000	11,00 \$
M 12	5	LEDSİZ	DÜZ	5 mt	C12-S5-5000	14,00 \$
M 12	5	LEDSİZ	90 DERECE	2 mt	C12-L5-2000	11,00 \$
M 12	5	LEDSİZ	90 DERECE	5 mt	C12-L5-5000	14,00 \$

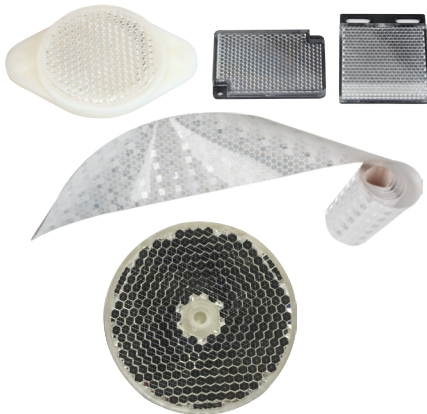

## Reflektörler

Ölçü	Kodu	Fiyat
30 mm Çaplı Kare Reflektör	RD-30	6,25 \$
80 mm Çaplı Yuvarlak Reflektör	RD-80	9,00 \$
40 mm * 60 mm Dikdörtgen Reflektör	RL-40	7,50 \$
50 mm * 50 mm Kare Reflektör	RL-50	7,75 \$
50 mm * 1000 mm Yapışkanlı Reflektör	R-501000	20,00 \$



ISISO ENDÜSTRİYEL OTOMASYON ÜRÜNLERİ

# Analog Girişli Trifaze Lineer (4-20mA) SSR'ler

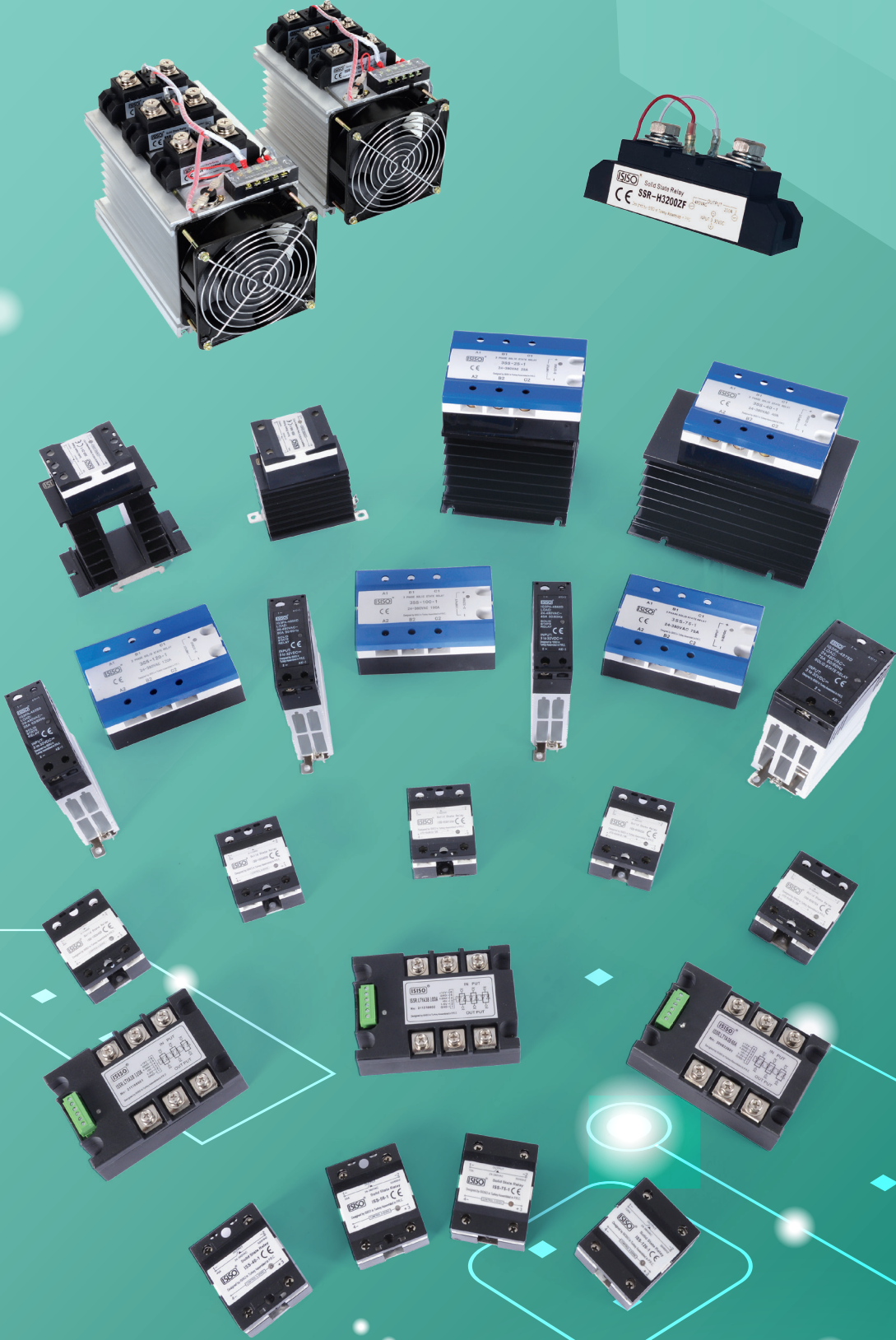

■ [www.soyluotomasyon.com](http://www.soyluotomasyon.com) ■



Akım	Giriş	Çıkış	Tipi	Kodu	Fiyat
25A	3-32 VDC	24-380 VAC	MONOFAZE	1SS-25-1	13,00 \$
40A	3-32 VDC	24-380 VAC	MONOFAZE	1SS-40-1	16,00 \$
50A	3-32 VDC	24-380 VAC	MONOFAZE	1SS-50-1	22,50 \$
75A	3-32 VDC	24-380 VAC	MONOFAZE	1SS-75-1	27,00 \$
100A	3-32 VDC	24-380 VAC	MONOFAZE	1SS-100-1	32,50 \$
120A	3-32 VDC	24-380 VAC	MONOFAZE	1SS-120-1	36,00 \$
25A	3-32 VDC	90-480 VAC	MONOFAZE	1SS-25-2	15,00 \$
40A	3-32 VDC	90-480 VAC	MONOFAZE	1SS-40-2	18,00 \$
50A	3-32 VDC	90-480 VAC	MONOFAZE	1SS-50-2	27,00 \$
75A	3-32 VDC	90-480 VAC	MONOFAZE	1SS-75-2	30,00 \$
100A	3-32 VDC	90-480 VAC	MONOFAZE	1SS-100-2	36,00 \$
120A	3-32 VDC	90-480 VAC	MONOFAZE	1SS-120-2	39,00 \$
25A	80-250 VAC	90-250 VAC	MONOFAZE	1SS-25-3	14,00 \$
40A	80-250 VAC	90-250 VAC	MONOFAZE	1SS-40-3	17,00 \$
50A	80-250 VAC	90-250 VAC	MONOFAZE	1SS-50-3	24,00 \$
100A	80-250 VAC	90-250 VAC	MONOFAZE	1SS-100-3	30,00 \$
25A	3-32 VDC	24-380 VAC	TRİFAZE	3SS-25-1	49,50 \$
40A	3-32 VDC	24-380 VAC	TRİFAZE	3SS-40-1	57,00 \$
75A	3-32 VDC	24-380 VAC	TRİFAZE	3SS-75-1	102,00 \$
100A	3-32 VDC	24-380 VAC	TRİFAZE	3SS-100-1	106,50 \$
120A	3-32 VDC	24-380 VAC	TRİFAZE	3SS-120-1	110,50 \$
25A	3-32 VDC	90-480 VAC	TRİFAZE	3SS-25-2	58,00 \$
40A	3-32 VDC	90-480 VAC	TRİFAZE	3SS-40-2	68,00 \$
75A	3-32 VDC	90-480 VAC	TRİFAZE	3SS-75-2	110,50 \$
100A	3-32 VDC	90-480 VAC	TRİFAZE	3SS-100-2	115,00 \$
120A	3-32 VDC	90-480 VAC	TRİFAZE	3SS-120-2	119,00 \$
25A	80-250 VAC	90-480 VAC	TRİFAZE	3SS-25-3	57,00 \$
40A	80-250 VAC	90-480 VAC	TRİFAZE	3SS-40-3	68,00 \$
75A	80-250 VAC	90-480 VAC	TRİFAZE	3SS-75-3	110,50 \$
100A	80-250 VAC	90-480 VAC	TRİFAZE	3SS-100-3	115,00 \$
120A	3-32 VDC	90-480 VAC	TRİFAZE-FANLI SOĞUTUCULU	3SS-120-SF	195,00 \$
150A	3-32 VDC	90-480 VAC	TRİFAZE-FANLI SOĞUTUCULU	3SS-150-SF	245,00 \$
200A	3-32 VDC	90-480 VAC	TRİFAZE-FANLI SOĞUTUCULU	3SS-200-SF	260,00 \$
250A	3-32 VDC	90-480 VAC	TRİFAZE-FANLI SOĞUTUCULU	3SS-250-SF	295,00 \$



## Analog Girişli Monofaze Linear (4-20mA) SSR'ler

Akım	Giriş	Çıkış	Tipi	Kodu	Fiyat
25A	4-20 mA	90-250 VAC	MONOFAZE	1SS-25-11	24,50 \$
40A	4-20 mA	90-250 VAC	MONOFAZE	1SS-40-11	30,00 \$
90A	4-20 mA	90-250 VAC	MONOFAZE	1SS-90-11	54,00 \$
25A	4-20 mA	250-480 VAC	MONOFAZE	1SS-25-12	30,00 \$
40A	4-20 mA	250-480 VAC	MONOFAZE	1SS-40-12	39,00 \$
90A	4-20 mA	250-480 VAC	MONOFAZE	1SS-90-12	69,50 \$



## Trifaze Linear (4-20mA) SSR'ler

Akım	Giriş	Çıkış	Tipi	Kodu	Fiyat
60A	4-20 mA/0-10VDC	24-380VAC	TRİFAZE	LTYA-3860	145,00 \$
80A	4-20 mA/0-10VDC	24-380VAC	TRİFAZE	LTYA-3880	150,00 \$
100A	4-20 mA/0-10VDC	24-380VAC	TRİFAZE	LTYA-38100	155,00 \$
120A	4-20 mA/0-10VDC	24-380VAC	TRİFAZE	LTYA-38120	175,00 \$



## Ray Montajlı Soğutucular

Cins	Kodu	Fiyat
25A'lık SSR için Ray Montajlı Monofaze Soğutucu	ISS-M-25A	9,25 \$
40A'lık SSR için Ray Montajlı Monofaze Soğutucu	ISS-M-40A	10,00 \$
75A'lık SSR için Ray Montajlı Monofaze Soğutucu	ISS-M-75A	12,00 \$
25A'lık SSR için Ray Montajlı Trifaze Soğutucu	ISS-T-25A	16,75 \$
40A'lık SSR için Ray Montajlı Trifaze Soğutucu	ISS-T-40A	17,00 \$
75A'lık SSR için Ray Montajlı Trifaze Soğutucu	ISS-T-75A	21,50 \$
SSR RAYA MONTAJ İÇİN APARAT	IK	5 \$

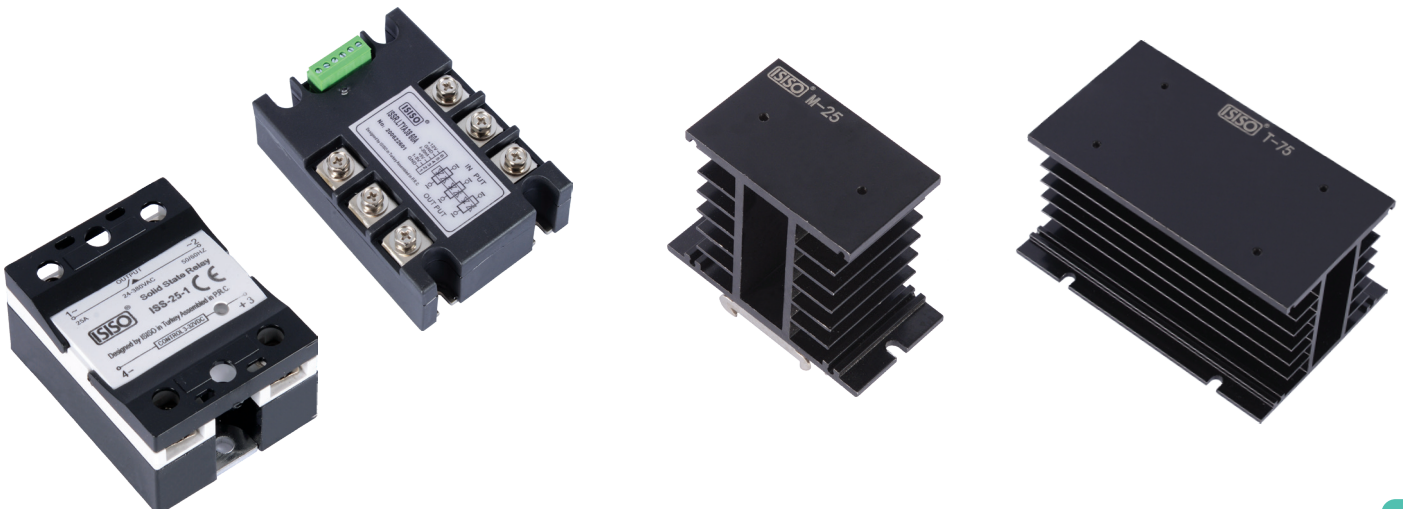
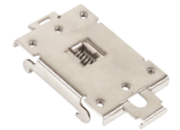
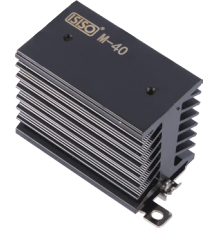



## Ray Montajlı Soğutuculu SSR



Akım	Giriş	Çıkış	Tipi	Kodu	Fiyat
25A	3-32 VDC	24-380 VAC	MONOFAZE	IG3PA-4825D	23,00 \$
40A	3-32 VDC	24-380 VAC	MONOFAZE	IG3PA-4840D	25,00 \$
50A	3-32 VDC	24-380 VAC	MONOFAZE	IG3PA-4850D	27,00 \$
75A	3-32 VDC	24-380 VAC	MONOFAZE	IG3PA-4875D	45,00 \$
90A	3-32 VDC	24-380 VAC	MONOFAZE	IG3PA-4890D	54,00 \$

## Potansiyometre ile Sürülebilir SSR



Akım	Giriş	Çıkış	Tipi	Kodu	Fiyat
25A	500 KΩ	24-380 VAC	MONOFAZE	ISS-R3825A	13,00 \$
50A	500 KΩ	24-380 VAC	MONOFAZE	ISS-R3850A	22,50 \$
75A	500 KΩ	24-380 VAC	MONOFAZE	ISS-R3875A	27,00 \$
100A	500 KΩ	24-380 VAC	MONOFAZE	ISS-R38100A	32,50 \$
120A	500 KΩ	24-380 VAC	MONOFAZE	ISS-R38120A	36,00 \$

## DC Giriş - DC Çıkış



Akım	Giriş	Çıkış	Tipi	Kodu	Fiyat
25A	3-32 VDC	5-60 VDC	MONOFAZE	ISS-1D0625D	13,00 \$
40A	3-32 VDC	5-60 VDC	MONOFAZE	ISS-1D0640D	16,00 \$
50A	3-32 VDC	5-60 VDC	MONOFAZE	ISS-1D0650D	22,50 \$
75A	3-32 VDC	5-60 VDC	MONOFAZE	ISS-1D0675D	27,00 \$
100A	3-32 VDC	5-60 VDC	MONOFAZE	ISS-1D06100D	32,50 \$

## SSR'ler



Akım	Giriş	Çıkış	Tipi	Kodu	Fiyat
120A	3-32 VDC	24-380 VAC	MONOFAZE	SSR-H3120ZF	43,00 \$
150A	3-32 VDC	24-380 VAC	MONOFAZE	SSR-H3150ZF	51,00 \$
200A	3-32 VDC	24-380 VAC	MONOFAZE	SSR-H3200ZF	56,00 \$
250A	3-32 VDC	24-380 VAC	MONOFAZE	SSR-H3250ZF	62,00 \$





ISISO ENDÜSTRİYEL OTOMASYON ÜRÜNLERİ



www.soyluotomasyon.com



Tip	Kontakt Düzeni	Renk	Çap / mm	Voltaj	Tip	Referans	Fiyat
<b>Yaylı Butonlar</b>	1 NA	Siyah	22 mm	Işıksız	Yaylı	ISP-AA21	3,50 \$
	1 NA	Yeşil	22 mm	Işıksız	Yaylı	ISP-AA31	3,50 \$
	1 NA	Sarı	22 mm	Işıksız	Yaylı	ISP-AA51	3,50 \$
	1 NA	Mavi	22 mm	Işıksız	Yaylı	ISP-AA61	3,50 \$
	1 NK	Kırmızı	22 mm	Işıksız	Yaylı	ISP-AA42	3,50 \$
<b>Mantar Kafalı Butonlar</b>	1 NA	Siyah	22 mm	Işıksız	Yaylı	ISP-AC21	4 \$
	1 NA	Yeşil	22 mm	Işıksız	Yaylı	ISP-AC31	4 \$
<b>İşikli Yaylı Buton</b>	1 NA	Sarı	22 mm	Işıksız	Yaylı	ISP-AC51	4 \$
	1 NA	Kırmızı	22 mm	Işıksız	Yaylı	ISP-AC42	4 \$
<b>İşikli Yaylı Buton</b>	1 NA+1 NK	Beyaz	22 mm	24V AC-DC	Yaylı	ISP-AW31B5	8 \$
	1 NA+1 NK	Yeşil	22 mm	24V AC-DC	Yaylı	ISP-AW33B5	8 \$
	1 NA+1 NK	Kırmızı	22 mm	24V AC-DC	Yaylı	ISP-AW34B5	8 \$
	1 NA+1 NK	Sarı	22 mm	24V AC-DC	Yaylı	ISP-AW35B5	8 \$
	1 NA+1 NK	Mavi	22 mm	24V AC-DC	Yaylı	ISP-AW36B5	8 \$
	1 NA+1 NK	Beyaz	22 mm	220V AC	Yaylı	ISP-AW31M5	9 \$
	1 NA+1 NK	Yeşil	22 mm	220V AC	Yaylı	ISP-AW33M5	9 \$
	1 NA+1 NK	Kırmızı	22 mm	220V AC	Yaylı	ISP-AW34M5	9 \$
	1 NA+1 NK	Sarı	22 mm	220V AC	Yaylı	ISP-AW35M5	9 \$
	1 NA+1 NK	Mavi	22 mm	220V AC	Yaylı	ISP-AW36M5	9 \$
<b>Acil Stop Butonu</b>	1 NK	Kırmızı	22 mm	Işıksız	Yaylı	ISP-AS542	6 \$
<b>Çift Yaylı İkiz Buton</b>	1 NA+1 NK	Yeşil + Kırmızı	22 mm	Işıksız	Yaylı	ISP-AL845	8 \$
	1 NA+1 NK	Yeşil + Kırmızı	22 mm	24V AC-DC	Yaylı	ISP-AW84B5	9,50 \$
	1 NA+1 NK	Yeşil + Kırmızı	22 mm	220V AC	Yaylı	ISP-AW84M5	11 \$
<b>Mandal Butonlar</b>	1 NA	Siyah	22 mm	Işıksız	Kalıcı	ISP-AD21	4,25 \$
	1 NA+1NA	Siyah	22 mm	Işıksız	Kalıcı	ISP-AD33	5,50 \$
	1 NA+1NA	Siyah	22 mm	Işıksız	Yaylı	ISP-AD53	5,50 \$
<b>Kilitli Butonlar</b>	1 NA	Siyah	22 mm	Işıksız	Kalıcı	ISP-AG21	11 \$
	1 NA+1NA	Siyah	22 mm	Işıksız	Kalıcı	ISP-AG03	11 \$
<b>İşikli Mandal Butonlar</b>	1 NA+1NK	Yeşil	22 mm	24V AC-DC	Kalıcı	ISP-AK123B5	7,75 \$
	1 NA+1NK	Kırmızı	22 mm	24V AC-DC	Kalıcı	ISP-AK124B5	7,75 \$
	1 NA+1NK	Sarı	22 mm	24V AC-DC	Kalıcı	ISP-AK125B5	7,75 \$
	1 NA+1NK	Yeşil	22 mm	220V AC	Kalıcı	ISP-AK123M5	8,50 \$
	1 NA+1NK	Kırmızı	22 mm	220V AC	Kalıcı	ISP-AK124M5	8,50 \$
	1 NA+1NK	Sarı	22 mm	220V AC	Kalıcı	ISP-AK125M5	8,50 \$
<b>İşikli Mandal Butonlar</b>	1 NA+1NK	Yeşil	22 mm	24V AC-DC	Kalıcı	ISP-AK133B5	8 \$
	1 NA+1NK	Kırmızı	22 mm	24V AC-DC	Kalıcı	ISP-AK134B5	8 \$
	1 NA+1NK	Turuncu	22 mm	24V AC-DC	Kalıcı	ISP-AK135B5	8 \$
	1 NA+1NK	Yeşil	22 mm	220V AC	Kalıcı	ISP-AK133M5	8,50 \$
	1 NA+1NK	Kırmızı	22 mm	220V AC	Kalıcı	ISP-AK134M5	8,50 \$
	1 NA+1NK	Sarı	22 mm	220V AC	Kalıcı	ISP-AK135M5	8,50 \$
<b>Kontakt Blokları</b>	1 NA	Yeşil	22 mm			ISK-101	2,00 \$
	1 NK	Kırmızı	22 mm			ISK-102	2,00 \$



# Butonlar (Metal Seri)

# BUTONLAR (Metal seri)



Tip	Kontakt Düzeni	Renk	Çap / mm	Voltaj	Tip	Referans	Fiyat	
Yaylı Butonlar	1 NA	Siyah	22 mm	Işıksız	Yaylı	ISM-BA21	4,75 \$	
	1 NA	Yeşil	22 mm	Işıksız	Yaylı	ISM-BA31	4,75 \$	
	1 NA	Sarı	22 mm	Işıksız	Yaylı	ISM-BA51	4,75 \$	
	1 NA	Mavi	22 mm	Işıksız	Yaylı	ISM-BA61	4,75 \$	
	1 NK	Kırmızı	22 mm	Işıksız	Yaylı	ISM-BA42	4,75 \$	
Mantar Kafalı Butonlar	1 NA	Siyah	22 mm	Işıksız	Yaylı	ISM-BC21	6 \$	
	1 NA	Yeşil	22 mm	Işıksız	Yaylı	ISM-BC31	6 \$	
Butonlar	1 NA	Sarı	22 mm	Işıksız	Yaylı	ISM-BC51	6 \$	
	1 NA	Kırmızı	22 mm	Işıksız	Yaylı	ISM-BC42	6 \$	
Işıklı Yaylı Buton	1 NA+1 NK	Beyaz	22 mm	24V AC-DC	Yaylı	ISM-BW31B5	8,25 \$	
	24V AC-DC besleme	1 NA+1 NK	Yeşil	22 mm	24V AC-DC	Yaylı	ISM-BW33B5	8,25 \$
	1 NA+1 NK	Kırmızı	22 mm	24V AC-DC	Yaylı	ISM-BW34B5	8,25 \$	
	1 NA+1 NK	Sarı	22 mm	24V AC-DC	Yaylı	ISM-BW35B5	8,25 \$	
	1 NA+1 NK	Mavi	22 mm	24V AC-DC	Yaylı	ISM-BW36B5	8,25 \$	
	220V AC besleme	1 NA+1 NK	Beyaz	22 mm	220V AC	Yaylı	ISM-BW31M5	9,25 \$
	1 NA+1 NK	Yeşil	22 mm	220V AC	Yaylı	ISM-BW33M5	9,25 \$	
	1 NA+1 NK	Kırmızı	22 mm	220V AC	Yaylı	ISM-BW34M5	9,25 \$	
	1 NA+1 NK	Sarı	22 mm	220V AC	Yaylı	ISM-BW35M5	9,25 \$	
	1 NA+1 NK	Mavi	22 mm	220V AC	Yaylı	ISM-BW36M5	9,25 \$	
Acil Stop Butonu	1 NK	Kırmızı	22 mm	Işıksız	Yaylı	ISM-BS542	7 \$	
Çift Yaylı İkiz Buton	1 NA+1 NK	Yeşil + Kırmızı	22 mm	Işıksız	Yaylı	ISM-BL845	9 \$	
	24V AC-DC besleme	1 NA+1 NK	Yeşil + Kırmızı	22 mm	24V AC-DC	Yaylı	ISM-BW84B5	11 \$
	220V AC besleme	1 NA+1 NK	Yeşil + Kırmızı	22 mm	220V AC	Yaylı	ISM-BW84M5	14 \$
Mandal Butonlar	1 NA	Siyah	22 mm	Işıksız	Kalıcı ✓	ISM-BD21	6 \$	
	1 NA+1NA	Siyah	22 mm	Işıksız	Kalıcı ✓	ISM-BD33	7,75 \$	
	1 NA+1NA	Siyah	22 mm	Işıksız	Yaylı ✓	ISM-BD53	7,75 \$	
Kilitli Butonlar	1 NA	Siyah	22 mm	Işıksız	Kalıcı ✓	ISM-BG21	11,50 \$	
	1 NA+1NA	Siyah	22 mm	Işıksız	Kalıcı ✓	ISM-BG03	12,50 \$	
Işıklı Mandal Butonlar	1 NA+1NK	Yeşil	22 mm	24V AC-DC	Kalıcı ✓	ISM-BK123B5	9 \$	
	24V AC-DC besleme	1 NA+1NK	Kırmızı	22 mm	24V AC-DC	Kalıcı ✓	ISM-BK124B5	9 \$
	1 NA+1NK	Sarı	22 mm	24V AC-DC	Kalıcı ✓	ISM-BK125B5	9 \$	
	220V AC besleme	1 NA+1NK	Yeşil	22 mm	220V AC	Kalıcı ✓	ISM-BK123M5	11,50 \$
	1 NA+1NK	Kırmızı	22 mm	220V AC	Kalıcı ✓	ISM-BK124M5	11,50 \$	
	1 NA+1NK	Sarı	22 mm	220V AC	Kalıcı ✓	ISM-BK125M5	11,50 \$	
Işıklı Mandal Butonlar	1 NA+1NK	Yeşil	22 mm	24V AC-DC	Kalıcı ✓	ISM-BK133B5	10,50 \$	
	24V AC-DC besleme	1 NA+1NK	Kırmızı	22 mm	24V AC-DC	Kalıcı ✓	ISM-BK134B5	10,50 \$
	1 NA+1NK	Turuncu	22 mm	24V AC-DC	Kalıcı ✓	ISM-BK135B5	10,50 \$	
	220V AC besleme	1 NA+1NK	Yeşil	22 mm	220V AC	Kalıcı ✓	ISM-BK133M5	12,50 \$
	1 NA+1NK	Kırmızı	22 mm	220V AC	Kalıcı ✓	ISM-BK134M5	12,50 \$	
1 NA+1NK	Sarı	22 mm	220V AC	Kalıcı ✓	ISM-BK135M5	12,50 \$		

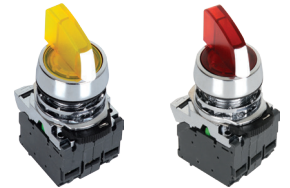





## Buton Işık Konağı

Renk	Besleme	Ürün Kodu	Fiyat
Beyaz	24 VAC/DC	ISK-1B	1,75 \$
Yeşil	24 VAC/DC	ISK-3B	1,75 \$
Kırmızı	24 VAC/DC	ISK-4B	1,75 \$
Sarı	24 VAC/DC	ISK-5B	1,75 \$
Mavi	24 VAC/DC	ISK-6B	1,75 \$
Beyaz	220 VAC	ISK-1M	2,00 \$
Yeşil	220 VAC	ISK-3M	2,00 \$
Kırmızı	220 VAC	ISK-4M	2,00 \$
Sarı	220 VAC	ISK-5M	2,00 \$
Mavi	220 VAC	ISK-6M	2,00 \$



## Sinyal Lambaları

Özellik	Besleme	Çap	Ürün Kodu	Fiyat
Düz Cam	24 VAC/DC	16 mm	AD136-16DS/24V Yeşil	1,07 \$
Düz Cam	24 VAC/DC	16 mm	AD136-16DS/24V Kırmızı	1,07 \$
Düz Cam	24 VAC/DC	16 mm	AD136-16DS/24V Sarı	1,07 \$
Düz Cam	24 VAC/DC	16 mm	AD136-16DS/24V Mavi	1,07 \$
Düz Cam	24 VAC/DC	16 mm	AD136-16DS/24V Beyaz	1,20 \$
Düz Cam	220 VAC	16 mm	AD136-16DS/230V Yeşil	1,07 \$
Düz Cam	220 VAC	16 mm	AD136-16DS/230V Kırmızı	1,07 \$
Düz Cam	220 VAC	16 mm	AD136-16DS/230V Sarı	1,07 \$
Düz Cam	220 VAC	16 mm	AD136-16DS/230V Mavi	1,07 \$
Düz Cam	220 VAC	16 mm	AD136-16DS/230V Beyaz	1,20 \$



Özellik	Besleme	Çap	Renk	Ürün Kodu	Fiyat
Düz Cam	24 VAC/DC	22 mm	Yeşil	ISS-EV03BPE	0,72 \$
Düz Cam	24 VAC/DC	22 mm	Kırmızı	ISS-EV04BPE	0,72 \$
Düz Cam	24 VAC/DC	22 mm	Sarı	ISS-EV05BPE	0,72 \$
Düz Cam	24 VAC/DC	22 mm	Mavi	ISS-EV06BPE	0,72 \$
Düz Cam	24 VAC/DC	22 mm	Beyaz	ISS-EV07BPE	0,90 \$
Düz Cam	220 VAC	22 mm	Yeşil	ISS-EV03MPE	0,72 \$
Düz Cam	220 VAC	22 mm	Kırmızı	ISS-EV04MPE	0,72 \$
Düz Cam	220 VAC	22 mm	Sarı	ISS-EV05MPE	0,72 \$
Düz Cam	220 VAC	22 mm	Mavi	ISS-EV06MPE	0,72 \$
Düz Cam	220 VAC	22 mm	Beyaz	ISS-EV07MPE	0,90 \$



## Ampermetre

Özellik	Besleme	Çap	Renk	Ürün Kodu	Fiyat
Düz Cam	100A	22 mm	Yeşil	AD136-22DSA-Y	6,00 \$
Düz Cam	100A	22 mm	Kırmızı	AD136-22DSA-K	6,00 \$
Düz Cam	100A	22 mm	Sarı	AD136-22DSA-S	6,00 \$
Düz Cam	100A	22 mm	Mavi	AD136-22DSA-M	6,00 \$
Düz Cam	100A	22 mm	Beyaz	AD136-22DSA-B	6,00 \$

\* Akım Trafosu Fiyata Dahildir.

## Voltmetre

Özellik	Besleme	Çap	Renk	Ürün Kodu	Fiyat
Düz Cam	24-450V	22 mm	Yeşil	AD136-22DSV-Y	2,70 \$
Düz Cam	24-450V	22 mm	Kırmızı	AD136-22DSV-K	2,70 \$
Düz Cam	24-450V	22 mm	Sarı	AD136-22DSV-S	2,70 \$
Düz Cam	24-450V	22 mm	Mavi	AD136-22DSV-M	2,70 \$
Düz Cam	24-450V	22 mm	Beyaz	AD136-22DSV-B	2,70 \$

## Buzzer

Özellik	Besleme	Çap	Renk	Ürün Kodu	Fiyat
Işıklı Buzzer	220VAC	16mm	Kırmızı	AD136-16D/SM-220V	2,60 \$
Işıklı Buzzer	24 AC/DC	16 mm	Kırmızı	AD136-16D/SM-24V	2,60 \$
Işıklı Buzzer	220VAC	22 mm	Kırmızı	AD136-22D/SM-220V	2,80 \$
Işıklı Buzzer	24 AC/DC	22 mm	Kırmızı	AD136-22D/SM-24V	2,80 \$



## Ø70 mm Işıklı Kolonlar



	Voltaj	Açıklama	Ürün Kodu	Fiyat
1 KAT	220V	Sabit, Flaşör, Çakar, Döner, Buzzer	IS70-1T/W-J 220V	36,50 \$
1 KAT	24VDC	Sabit, Flaşör, Çakar, Döner, Buzzer	IS70-1T/W-J 24VDC	40,00 \$
2 KAT	220V	Sabit, Flaşör, Çakar, Döner, Buzzer	IS70-2T/W-J 220V	46,50 \$
2 KAT	24VDC	Sabit, Flaşör, Çakar, Döner, Buzzer	IS70-2T/W-J 24VDC	53,50 \$
3 KAT	220V	Sabit, Flaşör, Çakar, Döner, Buzzer	IS70-3T/W-J 220V	53,00 \$
3 KAT	24VDC	Sabit, Flaşör, Çakar, Döner, Buzzer	IS70-3T/W-J 24VDC	58,50 \$
4 KAT	220V	Sabit, Flaşör, Çakar, Döner, Buzzer	IS70-4T/W-J 220V	36,50 \$
4 KAT	24VDC	Sabit, Flaşör, Çakar, Döner, Buzzer	IS70-4T/W-J 24VDC	40,00 \$
5 KAT	220V	Sabit, Flaşör, Çakar, Döner, Buzzer	IS70-5T/W-J 220V	46,50 \$
5 KAT	24VDC	Sabit, Flaşör, Çakar, Döner, Buzzer	IS70-5T/W-J 24VDC	53,50 \$

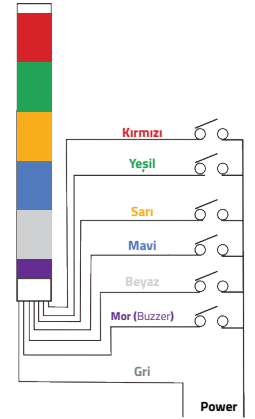

U Tipi Montaj Ayak  
4,00 \$



V Tipi Montaj Ayak  
4,00 \$



W Tipi Montaj Ayak  
9,00 \$



X Tipi Montaj Ayak  
9,25 \$



L Tipi Montaj Ayak  
4,50 \$

## Ø53 mm Işıklı Kolonlar



	Voltaj	Açıklama	Ürün Kodu	Fiyat
1 KAT	220V	Sabit, Flaşör, Çakar, Döner, Buzzer	IS53-1T/W-J 220V	21,00 \$
1 KAT	24V	Sabit, Flaşör, Çakar, Döner, Buzzer	IS53-1T/W-J 24V	21,00 \$
2 KAT	220V	Sabit, Flaşör, Çakar, Döner, Buzzer	IS53-2T/W-J 220V	25,00 \$
2 KAT	24V	Sabit, Flaşör, Çakar, Döner, Buzzer	IS53-2T/W-J 24V	25,00 \$
3 KAT	220V	Sabit, Flaşör, Çakar, Döner, Buzzer	IS53-3T/W-J 220V	30,00 \$
3 KAT	24V	Sabit, Flaşör, Çakar, Döner, Buzzer	IS53-3T/W-J 24V	30,00 \$

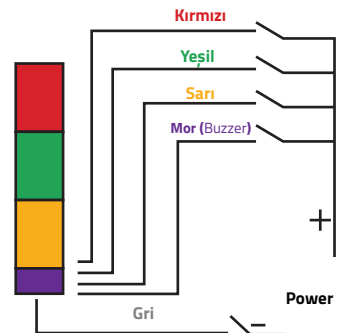

D Tipi Montaj Ayak  
4,00 \$



E Tipi Montaj Ayak  
4,00 \$



F Tipi Montaj Ayak  
4,00 \$



H Tipi Montaj Ayak  
4,00 \$

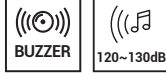
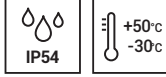

## Ø60 Borulu İkaz Lambaları

Voltaj	Açıklama	Ürün Kodu	Fiyat
24VDC	Sabit, Flaşör, Çakar, Buzzer	IS60ADB-24VDC	42 \$
220V	Sabit, Flaşör, Çakar, Buzzer	IS60ADB-220VAC	42 \$

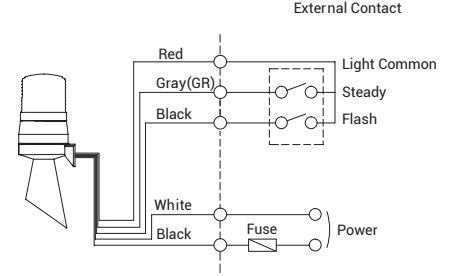
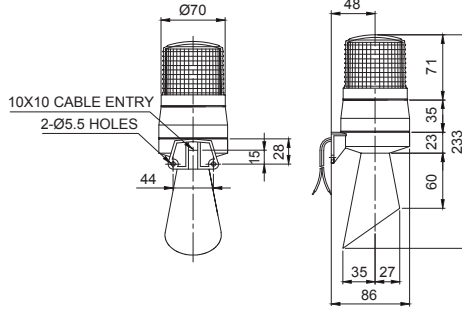

## Ø50 İkaz Lambaları

Voltaj	Açıklama	Ürün Kodu	Fiyat
24VDC	3 Renk Buzzer	IS5052RGY-T-J 24V	21 \$
220VAC	3 Renk Buzzer	IS5052RGY-T-J 220V	21 \$

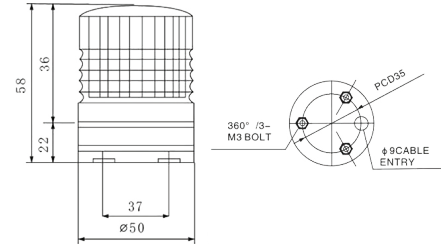
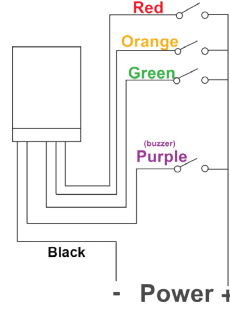

## Motorlu Sirenler



Ürün Kodu	Açıklama	Fiyat
MS-190-220	75mm Metal Gövde 220V. AC (110 - 130dB)	12,50 \$
MS-190-24	75mm Metal Gövde 24V. DC (110 - 130dB)	12,50 \$

## Çap 22 mm Potansiyometre Tek Turlu



Ürün Kodu	Açıklama	Fiyat
LA42DWQ22-2K	22mm Potans	11,00 \$
LA42DWQ22-5K	22mm Potans	11,00 \$
LA42DWQ22-10K	22mm Potans	11,00 \$





# Yüksükler, Kablo Bağları, SKP Pabuçlar, Yapışkanlı Kroşeler El Aletleri, Rakorlar, Makaronlar

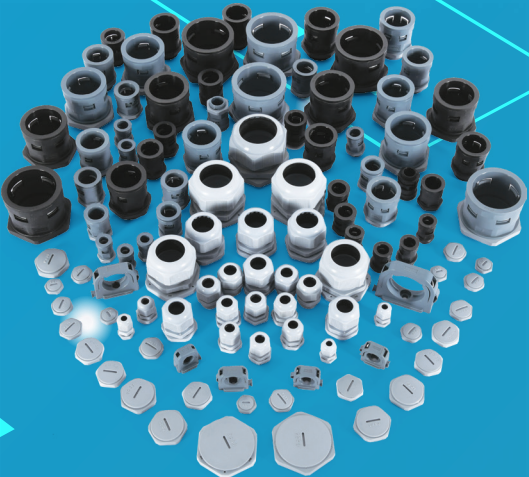



FSA156B

135 \$



İZOLESİZ TERMİNAL SIKMA PENSESİ  
0.5-1.5,1.5-2.5,4-6mm<sup>2</sup>



FSC-056YJ

55 \$



İZOLELİ TERMİNAL SIKMA PENSESİ  
1.5,2.5,4-6mm<sup>2</sup>



DR-616 TD

45 \$



İZOLELİ TERMİNAL SIKMA PENSESİ  
1.5, 2.5, 4-6 mm<sup>2</sup>

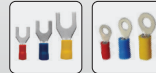

HS-30J

40 \$



İZOLELİ TERMİNAL SIKMA PENSESİ  
1.5,2.5,4-6mm<sup>2</sup>



HT-315

27 \$



KONNEKTÖR SIKMA PENSESİ  
RJ10 / RJ11 / RJ45



SN-02B

35 \$



İZOLESİZ TERMİNAL SIKMA PENSESİ  
1.5 6.0 mm<sup>2</sup>



HS-03B

37 \$



İZOLESİZ TERMİNAL SIKMA PENSESİ  
1.5-6.0mm<sup>2</sup>



SN-06WF

38 \$



YÜKSÜK SIKMA PENSESİ  
0.25-6.0mm<sup>2</sup>



HS-700D

20 \$



KABLO SIYIRMA PENSESİ  
0.25 2.5 mm<sup>2</sup>

DR-D3

26 \$



KABLO SIYIRMA PENSESİ  
0.08 6.0 mm<sup>2</sup> bl

HSC8 6-4

65 \$



YÜKSÜK SIKMA PENSESİ  
0.08-6.0mm<sup>2</sup>  
4 Köşe



HSC8 6-6

80 \$



YÜKSÜK SIKMA PENSESİ  
0.08-6.0mm<sup>2</sup>  
6 Köşe



HSC8 16-4

90 \$



YÜKSÜK SIKMA PENSESİ  
4-16mm<sup>2</sup>



# İSISO Zupper El Aletleri



EL ALETLERİ



AN-004 53 \$

İZOLESİZ TERMİNAL SIKMA PENSESİ  
0.5-10 mm<sup>2</sup>

AN-006 53 \$

İZOLELİ TERMİNAL VE  
KONNEKTÖR SIKMA PENSESİ  
0.5-6 mm<sup>2</sup>

AN-004WFL 52,50 \$

YÜKSÜK SIKMA PENSESİ  
0.5-6 mm<sup>2</sup>

ZSY10-6 80 \$

YÜKSÜK SIKMA PENSESİ - 0.08-10 mm<sup>2</sup>

HSC8 6-4A 68,50 \$

YÜKSÜK SIKMA PENSESİ - 0.25-6 mm<sup>2</sup>

CT-38 120 \$

SKP SIKMA PENSESİ - 8-38 mm<sup>2</sup>

CT-80 170 \$

SKP SIKMA PENSESİ - 8-95 mm<sup>2</sup>

IYYQ-120 114 \$

HİDROLİK SKP SIKMA PENSESİ  
10-120 mm<sup>2</sup>

IYQK-300 126 \$

HİDROLİK SKP SIKMA PENSESİ  
16-300 mm<sup>2</sup>

YQK-120 110 \$

HİDROLİK SKP SIKMA PENSESİ  
10-120 mm<sup>2</sup>

YQK-300 120 \$

HİDROLİK SKP SIKMA PENSESİ  
16-300 mm<sup>2</sup>

## Kablo Kesme Makasları

LK-60 25 \$

60 mm<sup>2</sup> Kablo Kesme Makası

CC-100 75 \$

120 mm<sup>2</sup> Kablo Kesme Makası

CC-250 150 \$

250 mm<sup>2</sup> Kablo Kesme Makası

CC-500 210 \$

630 mm<sup>2</sup> Kablo Kesme Makası

## İZOLELİ Tek Girişli Yüksükleri

Sipariş Kodu	KESİT mm <sup>2</sup>	Ebatlar (mm)					Renk	Kutu Adet	Birim Fiyat
		F	L	W	B	C			
VEF 0308	0.30 mm <sup>2</sup>	8	12	1,9	4,4	1,1	Menekşe	2000	0,0105 \$
VEF 0508	0.50 mm <sup>2</sup>	8	14	2,6	6	1,3	Beyaz	1000	0,0046 \$
VEF 7508	0.75 mm <sup>2</sup>	8	14	2,8	6,3	1,5	Mavi	1000	0,0046 \$
VEF 1008	1.00 mm <sup>2</sup>	8	14	3,0	6,3	1,7	Kırmızı	1000	0,0049 \$
VEF 1508	1.50 mm <sup>2</sup>	8	14	3,5	6,3	2	Siyah	1000	0,0056 \$
VEF 2508	2.50 mm <sup>2</sup>	8	14	4,2	7,4	2,5	Gri	500	0,0070 \$
VEF 4009	4.00 mm <sup>2</sup>	10	17	4,8	7,4	3,2	Turuncu	500	0,0095 \$
VEF 6012	6.00 mm <sup>2</sup>	12	20	6,3	8,5	3,9	Yeşil	250	0,0160 \$
VEF 10-12	10.00 mm <sup>2</sup>	12	22	7,6	8,8	4,9	Kahve	100	0,0240 \$
VEF 16-12	16.00 mm <sup>2</sup>	12	24	8,8	10	6,2	Bej	100	0,0310 \$
VEF 25-16	25.00 mm <sup>2</sup>	16	28	11,2	12	7,7	Siyah	50	0,0630 \$
VEF 35-16	35.00 mm <sup>2</sup>	16	30	12,7	14	8,7	Kırmızı	50	0,0780 \$
VEF 50-20	50.00 mm <sup>2</sup>	20	36	15	16	10,9	Mavi	25	0,1800 \$
VEF 70-21	70.00 mm <sup>2</sup>	21	37	16	17	14,3	Sarı	25	0,2700 \$

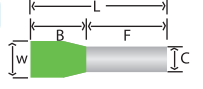

## İZOLELİ Çift Girişli Yüksükleri

Sipariş Kodu	KESİT mm <sup>2</sup>	Ebatlar (mm)					Renk	Kutu Adet	Birim Fiyat
		F	L	W	B	D			
TEF 0508	0.50 mm <sup>2</sup>	8	14	5	6,5	1,8	Beyaz	1000	0,0091 \$
TEF 7508	0.75 mm <sup>2</sup>	8	14	5,5	6,7	2,1	Mavi	500	0,0105 \$
TEF 1008	1.00 mm <sup>2</sup>	8	14	5,5	7,1	2,4	Kırmızı	500	0,0115 \$
TEF 1508	1.50 mm <sup>2</sup>	8	14	6,4	7,5	2,6	Siyah	500	0,0125 \$
TEF 2510	2.50 mm <sup>2</sup>	10	14	8	8,5	3,3	Gri	250	0,0250 \$
TEF 4012	4.00 mm <sup>2</sup>	12	17	8	11,1	4,2	Turuncu	200	0,0300 \$
TEF 6012	6.00 mm <sup>2</sup>	14	20	9,5	12,1	5,3	Yeşil	100	0,0480 \$
TEF 10-14	10.00 mm <sup>2</sup>	14	27	12,6	12,6	6,9	Kahve	50	0,0700 \$
TEF 16-14	16.00 mm <sup>2</sup>	14	31	19,0	17,3	8,7	Bej	50	0,1800 \$

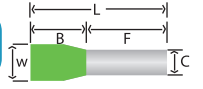

Tüm kutularda askı yöntemiyle  
stoklama yapılabilme avantajı !

# İZOLELİ Kablo Yüksükleri Alman Normu



YÜKSÜKLER



## İZOLELİ Tek Girişli Yüksükleri

Sipariş Kodu	KESİT mm <sup>2</sup>	Ebatlar (mm)					Renk	Kutu Adet	Birim Fiyat
		F	L	W	B	C			
VEA 0308	0.30 mm <sup>2</sup>	8	12	1,9	4,4	1,1	Turkuaz	2000	0,0105 \$
VEA 0508	0.50 mm <sup>2</sup>	8	14	2,6	6	1,3	Turuncu	1000	0,0046 \$
VEA 7508	0.75 mm <sup>2</sup>	8	14	2,8	6,3	1,5	Beyaz	1000	0,0046 \$
VEA 1008	1.00 mm <sup>2</sup>	8	14	3,0	6,3	1,7	Sarı	1000	0,0049 \$
VEA 1508	1.50 mm <sup>2</sup>	8	14	3,5	6,3	2	Kırmızı	1000	0,0056 \$
VEA 2508	2.50 mm <sup>2</sup>	8	14	4,2	7,4	2,5	Mavi	500	0,0070 \$
VEA 4009	4.00 mm <sup>2</sup>	10	17	4,8	7,4	3,2	Gri	500	0,0095 \$
VEA 6012	6.00 mm <sup>2</sup>	12	20	6,3	8,5	3,9	Siyah	250	0,0160 \$
VEA 10-12	10.00 mm <sup>2</sup>	12	22	7,6	8,8	4,9	Bej	100	0,0240 \$
VEA 16-12	16.00 mm <sup>2</sup>	12	24	8,8	10	6,2	Yeşil	100	0,0310 \$
VEA 25-16	25.00 mm <sup>2</sup>	16	28	11,2	12	7,7	Kahve	50	0,0630 \$
VEA 35-16	35.00 mm <sup>2</sup>	16	30	12,7	14	8,7	Bej	50	0,0780 \$
VEA 50-20	50.00 mm <sup>2</sup>	20	36	15	16	10,9	Yeşil	25	0,1800 \$

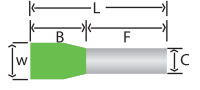

## İZOLELİ Çift Girişli Yüksükleri

Sipariş Kodu	KESİT mm <sup>2</sup>	Ebatlar (mm)					Renk	Kutu Adet	Birim Fiyat
		F	L	W	B	D			
TEA 0508	0.50 mm <sup>2</sup>	8	14	5	6,5	1,8	Turuncu	1000	0,0091 \$
TEA 7508	0.75 mm <sup>2</sup>	8	14	5,5	6,7	2,1	Beyaz	500	0,0105 \$
TEA 1008	1.00 mm <sup>2</sup>	8	14	5,5	7,1	2,4	Sarı	500	0,0115 \$
TEA 1508	1.50 mm <sup>2</sup>	8	14	6,4	7,5	2,6	Kırmızı	500	0,0125 \$
TEA 2510	2.50 mm <sup>2</sup>	10	14	8	8,5	3,3	Mavi	250	0,0250 \$
TEA 4012	4.00 mm <sup>2</sup>	12	17	8	11,1	4,2	Gri	200	0,0300 \$
TEA 6012	6.00 mm <sup>2</sup>	14	20	9,5	12,1	5,3	Siyah	100	0,0480 \$
TEA 10-14	10.00 mm <sup>2</sup>	14	27	12,6	12,6	6,9	Bej	50	0,0700 \$
TEA 16-14	16.00 mm <sup>2</sup>	14	31	19,0	17,3	8,7	Yeşil	50	0,1800 \$

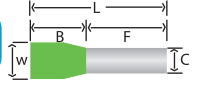

## İZOLESİZ Kablo Yüksükleri

Ürün Kodu	Kablo Kesit (mm <sup>2</sup> )	Ebatlar				Kutu Adet	Birim Fiyat
		L	W	D	C		
IY-0.50	0.50 mm <sup>2</sup>	10	2.1	1.3	1.0	2.000	0,0066 \$
IY-0.75	0.75 mm <sup>2</sup>	10	2.3	1.5	1.2	1.000	0,0066 \$
IY-1.00	1.00 mm <sup>2</sup>	10	2.5	1.7	1.4	1.000	0,0066 \$
IY-1.50	1.50 mm <sup>2</sup>	10	2.8	2.0	1.7	1.000	0,0074 \$
IY-2.50	2.50 mm <sup>2</sup>	12	3.4	2.5	2.2	1.000	0,0102 \$
IY-4.00	4.00 mm <sup>2</sup>	12	4.0	3.2	2.8	1.000	0,0140 \$
IY-6.00	6.00 mm <sup>2</sup>	12	4.7	3.9	3.5	500	0,0184 \$
IY-10.0	10.0 mm <sup>2</sup>	15	5.8	4.9	4.5	250	0,0300 \$
IY-16.0	16.0 mm <sup>2</sup>	15	7.5	6.2	5.8	250	0,0400 \$
IY-25.0	25.0 mm <sup>2</sup>	16	9.1	7.9	7.5	100	0,0600 \$
IY-35.0	35.0 mm <sup>2</sup>	16	10.2	8.7	8.3	100	0,0650 \$
IY-50.0 <sup>2</sup>	50.0 mm <sup>2</sup>	22	12.7	10.9	10.3	50	0,1500 \$

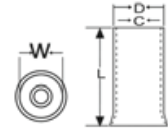



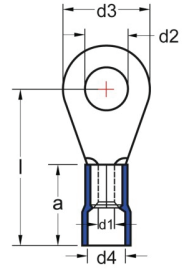

## Yuvarlak Tip İzoleli Kablo Uçları



Sipariş Kodu	Kablo Kesiti	Civata Ölçüsü	Ebatlar (mm)				Kutu Adet	Birim Fiyat
			D4	A	D2	L		
RV1.25-3	0.50-1.50 mm	M3	4	10	3,2	16	200	0,0230 \$
RV1.25-4		M4	4	10	4,3	17	200	0,0240 \$
RV1.25-5		M5	4	10	5,3	18	200	0,0260 \$
RV1.25-6		M6	4	10	6,5	22	200	0,0360 \$
RV 2-3	1.50-2.50 mm	M3	4,5	10	3,2	16	200	0,0240 \$
RV 2-4		M4	4,5	10	4,3	17	200	0,0265 \$
RV 2-5		M5	4,5	10	5,3	19	200	0,0310 \$
RV 2-6		M6	4,5	10	6,5	21	200	0,0410 \$
RV 2-8	4.0-6.0 mm	M8	4,5	10	8,4	22	200	0,0420 \$
RV 2-10		M10	4,5	10	10,5	22	200	0,0470 \$
RV 5.5-4		M4	6,3	13	4,3	21	100	0,0570 \$
RV 5.5-5		M5	6,3	13	5,3	22	100	0,0600 \$
RV 5.5-6	4.0-6.0 mm	M6	6,3	13	6,5	22,5	100	0,0670 \$
RV 5.5-8		M8	6,3	13	8,4	26	100	0,0950 \$
RV 5.5-10		M10	6,3	13	10,5	28	100	0,0960 \$
RV 5.5-12		M12	6,3	13	13,0	28	100	0,1000 \$

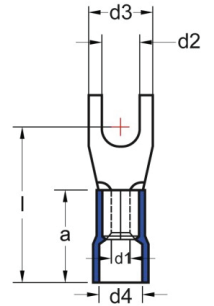

## Çatal Tip İzoleli Kablo Uçları



Sipariş Kodu	Kablo Kesiti	Civata Ölçüsü	Ebatlar (mm)				Kutu Adet	Birim Fiyat
			D4	A	D2	L		
SV 1.25-3	0.50-1.50 mm	M3	4	10	3,2	16	200	0,0220 \$
SV 1.25-4		M4	4	10	4,3	17	200	0,0230 \$
SV 1.25-5		M5	4	10	5,3	18	200	0,0250 \$
SV 1.25-6		M6	4	10	6,5	20	200	0,0290 \$
SV 2-3	1.50-2.50 mm	M3	4,5	10	3,2	18	200	0,0260 \$
SV 2-4		M4	4,5	10	4,3	17	200	0,0270 \$
SV 2-5		M5	4,5	10	5,3	19	200	0,0300 \$
SV 2-6		M6	4,5	10	6,5	21	200	0,0330 \$
SV 5.5-4	4.0-6.0 mm	M4	4,5	10	8,4	22	100	0,0600 \$
SV 5.5-5		M5	4,5	10	10,5	22	100	0,0610 \$
SV 5.5-6		M6	4,5	10	13,0	25	100	0,0620 \$
SV 5.5-8		M8	6,3	13	14,3	21	100	0,0800 \$

Sipariş Kodu

Kablo Kesiti

Kutu Adet

Birim Fiyat

### İğne Tip İzoleli Kablo Uçları

Ebatlar (mm)

		W	E	F	D	L		
<b>PTV 1.25-10</b>	0.50-1.50 mm	1,9	10	10	4	19	200	0,0270 \$
<b>PTV 2-10</b>	1.50-2.50 mm	1,9	10	12	4,5	21,8	200	0,0290 \$
<b>PTV 5.50-12</b>	4.0-6.0 mm	2,8	27	14	6,4	27	100	0,0700 \$

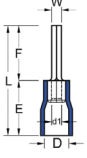

### Ek Mufları İzoleli Kablo Uçları

Ebatlar (mm)

		L	D	D1		
<b>BV 1.25</b>	0.50-1.50 mm	24,6	4	1,7	200	0,0390 \$
<b>BV 2</b>	1.50-2.50 mm	24,6	4,5	2,3	200	0,0430 \$
<b>BV 5.50</b>	4.0-6.0 mm	26,5	6,3	3,4	100	0,0650 \$

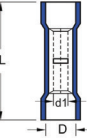

### Erkek Terminaller İzoleli Kablo Uçları

Ebatlar (mm)

		W	B	F	D	L		
<b>MPD 1.25-156</b>	0.50-1.50 mm	4,5	10,5	8,5	3,8	21,5	200	0,0300 \$
<b>MPD 2-156</b>	1.50-2.50 mm	5	10,5	8,5	4,7	21,2	200	0,0320 \$

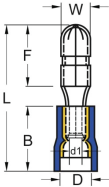

### Dişi Terminaller İzoleli Kablo Uçları

Ebatlar (mm)

		W	B	F	D	L		
<b>FRD 1.25-156</b>	0.50-1.50 mm	3,9	10,5	8,5	3,8	23,3	200	0,0400 \$
<b>FRD 2-156</b>	1.50-2.50 mm	4,9	10,5	8,5	4,7	23,3	200	0,0450 \$

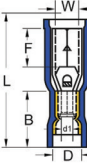

### Dişi Faston Tip İzoleli Kablo Uçları

Ebatlar (mm)

		W	B	F	D	L		
<b>FDD 1.25-187</b>	0.50-1.50 mm	5	10,5	6,4	3,8	19,4	200	0,0260 \$
<b>FDD 2-187</b>	1.50-2.50 mm	5	10,5	6,4	4,7	19,4	200	0,0260 \$
<b>FDD 2-250</b>	1.50-2.50 mm	6,6	10,5	7,5	4,7	22,5	200	0,0330 \$
<b>FDD 5.50-250</b>	4.0-6.0 mm	6,6	13	7,5	6,2	23,3	100	0,0450 \$

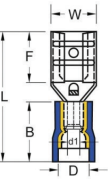

### Erkek Faston Tip İzoleli Kablo Uçları

Ebatlar (mm)

		W	E	F	D	L		
<b>MDD 1.25-187</b>	0.50-1.50 mm	4,8	10,5	6,7	3,8	17,2	200	0,0270 \$
<b>MDD 2-187</b>	1.50-2.50 mm	4,8	10,5	6,7	4,7	17,2	200	0,0290 \$
<b>MDD 2-250</b>	1.50-2.50 mm	6,6	10,5	7,5	4,7	22,5	200	0,0310 \$
<b>MDD 5.50-250</b>	4.0-6.0 mm	6,35	13	7,7	6,2	20,7	100	0,0470 \$

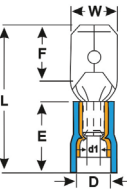

### Tam İzoleli Dişi Faston Kablo Uçları

Ebatlar (mm)

		W	E	F	D	L		
<b>FDFD 1.25-187</b>	0.50-1.50 mm	5	10,5	6,4	3,8	20,5	200	0,0400 \$
<b>FDFD 2-187</b>	1.50-2.50 mm	5	10,5	6,4	4,7	20,2	200	0,0410 \$
<b>FDFD 2-250</b>	1.50-2.50 mm	6,6	10,5	7,5	4,7	22,5	100	0,0450 \$
<b>FDFD 5.50-250</b>	4.0-6.0 mm	6,6	12,5	7,5	6,2	24,2	100	0,0620 \$

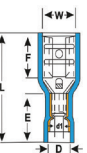

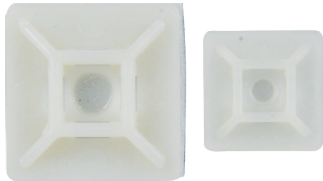

Sipariş Kodu	Kablo Kesiti	Kutu Adet	Birim Fiyat
AUTO TERMİNAL 2,8A	IF1/2D	300	0,0120 \$
AUTO TERMİNAL 4,8A	IF1D SMALL	300	0,0200 \$
AUTO TERMİNAL 6,3A	IF1D	300	0,0500 \$
AUTO TERMİNAL 2,8B	IF1/2E	300	0,0100 \$
AUTO TERMİNAL 4,8B	IF1E SMALL	300	0,0150 \$
AUTO TERMİNAL 6,3B	IF1E	300	0,0210 \$
INSULATE SLEEVE 2,8A	KILIF	300	0,008 \$
INSULATE SLEEVE 4,8A	KILIF	300	0,009 \$
INSULATE SLEEVE 6,3A	KILIF	300	0,010 \$

SNB 2-3	1,50-2,50 MM	500	0,0200 \$
SNB 2-4		500	0,0200 \$
SNB 2-5		500	0,0220 \$
SNB 2-5	4,00-6,00 MM	500	0,0260 \$
SNB 5,5-4		250	0,0420 \$
SNB 5,5-5		250	0,0430 \$
SNB 5,5-6	4,00-6,00 MM	250	0,0435 \$
SNB 5,5-8		250	0,0640 \$
RNB 1,25-3		0,50-1,50 MM	500
RNB 1,25-4S	500		0,0180 \$
RNB 1,25-5S	500		0,0200 \$
RNB 1,25-6	500		0,0310 \$
RNB 2-3	1,50-2,50 MM	500	0,0200 \$
RNB 2-4S		500	0,0200 \$
RNB 2-5S		500	0,0240 \$
RNB 2-6		500	0,0340 \$
RNB 5,5-4	4,00-6,00 MM	250	0,0420 \$
RNB 5,5-5S		250	0,0430 \$
RNB 5,5-6		250	0,0520 \$
RNB 5,5-8		250	0,0740 \$
RNB 5,5-10		100	0,0730 \$
RNB 5,5-12		100	0,0860 \$

## Yapışkanlı Kroşeler

Gri Kod	Siyah Kod	Boy ve Genişlik (mm)	Kutu Adet	Birim Fiyat
IYPK-G 20x20	IYPK-S 20x20	19x19 mm	100	0,0470 \$
IYPK-G 30x30	IYPK-S 30x30	28x28 mm	100	0,0800 \$



Kilitli poşet sayesinde ekonomik kullanım !

Sipariş Kodu	Uzunluk (mm)	En (mm)	Renk	Açılma Mukavemeti (kg)	Kutu Adeti	Birim Fiyat
BQLS 100x2,5	100	2,5	Beyaz	8	1000	0,0060 \$
BQLS 150x2,5	150	2,5	Beyaz	8	1000	0,0095 \$
BQLS 200x2,5	200	2,5	Beyaz	8	100	0,0135 \$
BQLS 150x3,6	150	3,6	Beyaz	18	100	0,0155 \$
BQLS 200x3,6	200	3,6	Beyaz	18	100	0,0205 \$
BQLS 250x3,6	250	3,6	Beyaz	18	100	0,0260 \$
BQLS 300x3,6	300	3,6	Beyaz	18	100	0,0318 \$
BQLS 400x3,8	400	3,8	Beyaz	18	100	0,0390 \$
BQLS 200x4,8	200	4,8	Beyaz	22	100	0,0280 \$
BQLS 250x4,8	250	4,8	Beyaz	22	100	0,0370 \$
BQLS 300x4,8	300	4,8	Beyaz	22	100	0,0430 \$
BQLS 400x4,8	400	4,8	Beyaz	22	100	0,0600 \$
BQLS 450x4,8	450	4,8	Beyaz	22	100	0,0750 \$
BQLS 500x4,8	500	4,8	Beyaz	22	100	0,1020 \$
BQLS 300x7,6	300	7,6	Beyaz	55	100	0,0850 \$
BQLS 400x7,6	400	7,6	Beyaz	55	100	0,1070 \$
BQLS 450x7,6	450	7,6	Beyaz	55	100	0,1500 \$
BQLS 500x7,6	500	7,6	Beyaz	55	100	0,1600 \$
BQLS 610x7,6	610	7,6	Beyaz	55	100	0,1700 \$
BQLS 750x7,6	750	7,6	Beyaz	55	100	0,2300 \$
BQLS 610x9,0	610	9,0	Beyaz	80	100	0,2500 \$
BQLS 720x9,0	710	9,0	Beyaz	80	100	0,2600 \$
BQLS 800x9,0	780	9,0	Beyaz	80	100	0,3000 \$
BQLS 900x9,0	920	9,0	Beyaz	80	100	0,3900 \$
BQLS 1200x9,0	1200	9,0	Beyaz	80	100	0,4900 \$

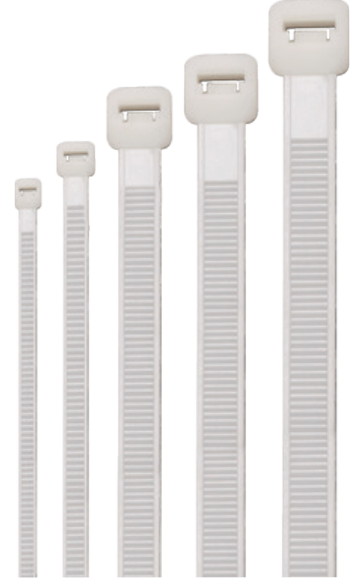

Sipariş Kodu	Uzunluk (mm)	En (mm)	Renk	Açılma Mukavemeti (kg)	Kutu Adeti	Birim Fiyat
SQSL 100x2,5	100	2,5	Siyah	8	1000	0,0060 \$
SQSL 150x2,5	150	2,5	Siyah	8	1000	0,0095 \$
SQSL 200x2,5	200	2,5	Siyah	8	100	0,0135 \$
SQSL 150x3,6	150	3,6	Siyah	18	100	0,0155 \$
SQSL 200x3,6	200	3,6	Siyah	18	100	0,0205 \$
SQSL 250x3,6	250	3,6	Siyah	18	100	0,0260 \$
SQSL 300x3,6	300	3,6	Siyah	18	100	0,0318 \$
SQSL 400x3,6	400	3,8	Siyah	18	100	0,0390 \$
SQSL 200x4,8	200	4,8	Siyah	22	100	0,0280 \$
SQSL 250x4,8	250	4,8	Siyah	22	100	0,0370 \$
SQSL 300x4,8	300	4,8	Siyah	22	100	0,0430 \$
SQSL 400x4,8	400	4,8	Siyah	22	100	0,0600 \$
SQSL 450x4,8	450	4,8	Siyah	22	100	0,0750 \$
SQSL 500x4,8	500	4,8	Siyah	22	100	0,1020 \$
SQSL 300x7,6	300	7,6	Siyah	55	100	0,0850 \$
SQSL 400x7,6	400	7,6	Siyah	55	100	0,1070 \$
SQSL 450x7,6	450	7,6	Siyah	55	100	0,1500 \$
SQSL 500x7,6	500	7,6	Siyah	55	100	0,1600 \$
SQSL 610x7,6	610	7,6	Siyah	55	100	0,1700 \$
SQSL 750x7,6	750	7,6	Siyah	55	100	0,2300 \$
SQSL 610x9,0	610	9,0	Siyah	80	100	0,2500 \$
SQSL 720x9,0	710	9,0	Siyah	80	100	0,2600 \$
SQSL 800x9,0	780	9,0	Siyah	80	100	0,3000 \$
SQSL 900x9,0	920	9,0	Siyah	80	100	0,3900 \$
SQSL 1200x9,0	1200	9,0	Siyah	80	100	0,4900 \$





**Koyu Kırmızı**

**Kırmızı**

## Cam Elyaf Silikon İzoleli Makaronlar 2500V (H Class)

Sipariş Kodu	Metraji	Renk	Birim Fiyat	Sipariş Kodu	Metraji	Renk	Birim Fiyat
ICM 2 MM	200	Kırmızı	0,260 \$	ICM-D 2 MM	200	Koyu Kırmızı	0,260 \$
ICM 3 MM	100	Kırmızı	0,320 \$	ICM-D 3 MM	100	Koyu Kırmızı	0,320 \$
ICM 4 MM	100	Kırmızı	0,380 \$	ICM-D 4 MM	100	Koyu Kırmızı	0,380 \$
ICM 5 MM	100	Kırmızı	0,490 \$	ICM-D 5 MM	100	Koyu Kırmızı	0,490 \$
ICM 6 MM	100	Kırmızı	0,600 \$	ICM-D 6 MM	100	Koyu Kırmızı	0,600 \$
ICM 7 MM	100	Kırmızı	0,770 \$	ICM-D 7 MM	100	Koyu Kırmızı	0,770 \$
ICM 8 MM	50	Kırmızı	0,810 \$	ICM-D 8 MM	50	Koyu Kırmızı	0,810 \$
ICM 10 MM	50	Kırmızı	1,160 \$	ICM-D 10 MM	50	Koyu Kırmızı	1,160 \$
ICM 12 MM	50	Kırmızı	1,400 \$	ICM-D 12 MM	50	Koyu Kırmızı	1,400 \$
ICM 14 MM	50	Kırmızı	1,920 \$	ICM-D 14 MM	50	Koyu Kırmızı	1,920 \$
ICM 16 MM	50	Kırmızı	2,450 \$	ICM-D 16 MM	50	Koyu Kırmızı	2,450 \$
ICM 18 MM	25	Kırmızı	3,600 \$	ICM-D 18 MM	25	Koyu Kırmızı	3,600 \$
ICM 20 MM	25	Kırmızı	4,300 \$	ICM-D 20 MM	25	Koyu Kırmızı	4,300 \$
ICM 25 MM	25	Kırmızı	7,600 \$	ICM-D 25 MM	25	Koyu Kırmızı	7,600 \$
ICM 30 MM	25	Kırmızı	11,000 \$	ICM-D 30 MM	25	Koyu Kırmızı	11,000 \$
ICM 35 MM	25	Kırmızı	15,000 \$	ICM-D 35 MM	25	Koyu Kırmızı	15,000 \$

## Kablo Toplama Çorabı

**YENİ  
ÜRÜN**

Sipariş Kodu	Ölçü	Esneleme Aralığı		Makara / Mt.	Birim Fiyatı
		Min (mm)	Min (mm)		
IKTÇ-3MM	3 mm	1	6	200	0,190 \$
IKTÇ-6MM	6 mm	3	9	150	0,230 \$
IKTÇ-8MM	8 mm	5	16	150	0,250 \$
IKTÇ-10MM	10 mm	7	19	100	0,290 \$
IKTÇ-12MM	12 mm	8	24	100	0,350 \$
IKTÇ-15MM	15 mm	10	27	100	0,390 \$
IKTÇ-20MM	20 mm	14	30	100	0,550 \$
IKTÇ-25MM	25 mm	18	35	100	0,630 \$
IKTÇ-30MM	30 mm	20	50	50	0,960 \$
IKTÇ-40MM	40 mm	30	60	50	1,350 \$
IKTÇ-50MM	50 mm	40	80	50	1,800 \$

## İçi Yapışkanlı Daralan Makaron

**YENİ  
ÜRÜN**

Sipariş Kodu	Ölçü	Daralmadan Sonra (mm)		Makara Mt.	Birim Fiyatı
		Azami İç Çap	Anma Cidar Kalınlığı		
IDM-YPK 6MM	6 mm	2.00	1.30 ± 0.10	100	0,880 \$
IDM-YPK 10MM	10.2 mm	3.00	1.70 ± 0.15	50	1,200 \$
IDM-YPK 12MM	12 mm	4.00	2.00 ± 0.20	1.20 Boy	1,700 \$
IDM-YPK 16MM	16 mm	5.00	2.20 ± 0.20	1.20 Boy	2,350 \$
IDM-YPK 19MM	19.1 mm	6.00	2.30 ± 0.20	1.20 Boy	3,300 \$
IDM-YPK 28MM	28 mm	9.00	2.40 ± 0.20	1.20 Boy	4,100 \$
IDM-YPK 33MM	33 mm	10.00	2.50 ± 0.20	1.20 Boy	5,000 \$
IDM-YPK 38MM	38.1 mm	12.00	2.50 ± 0.20	1.20 Boy	5,800 \$
IDM-YPK 43MM	43.2 mm	14.00	2.50 ± 0.20	1.20 Boy	6,200 \$
IDM-YPK 56MM	56 mm	18.00	2.50 ± 0.20	1.20 Boy	7,200 \$
IDM-YPK 75MM	75 mm	25.00	3.00 ± 0.30	1.20 Boy	12,000 \$
IDM-YPK 95MM	95 mm	30.00	3.00 ± 0.30	1.20 Boy	14,000 \$
IDM-YPK 125MM	125 mm	40.00	3.00 ± 0.30	1.20 Boy	22,000 \$

## Isı ile Daralan Makaronlar

MAKARONLAR

ISISO  
ISISO ENDÜSTRİYEL OTOMASYON ÜRÜNLERİ

Malzeme : Polyolefin Daralma Oranı : 2/1 Yanmazlık : Kendi kendine söner  
Çalışma Sıcaklığı : -55C...+125 C

Sipariş Kodu	Boyutlar (Daralmadan önce) İç Çap	Cıdar Kalınlığı	Uzunluk mt /makara	Birim Fiyat
IDM 1 MM	2,0 ± 0,3	0,16 ± 0,05	400	0,0600 \$
IDM 1.5 MM	2,0 ± 0,3	0,16 ± 0,05	400	0,0700 \$
IDM 2 MM	2,5 ± 0,3	0,16 ± 0,05	400	0,0830 \$
IDM 2.5 MM	3,0 ± 0,3	0,16 ± 0,05	400	0,1000 \$
IDM 3 MM	3,5 ± 0,4	0,20 ± 0,05	400	0,1100 \$
IDM 3.5 MM	4,0 ± 0,4	0,20 ± 0,05	400	0,1250 \$
IDM 4 MM	4,5 ± 0,4	0,20 ± 0,05	400	0,1400 \$
IDM 5 MM	5,5 ± 0,4	0,20 ± 0,05	200	0,1800 \$
IDM 6 MM	6,5 ± 0,4	0,22 ± 0,05	200	0,2110 \$
IDM 8 MM	8,5 ± 0,4	0,30 ± 0,08	100	0,2600 \$
IDM 10 MM	10,5 ± 0,5	0,30 ± 0,08	100	0,2900 \$
IDM 12 MM	12,5 ± 0,5	0,30 ± 0,10	100	0,3300 \$
IDM 14 MM	14,5 ± 0,5	0,33 ± 0,10	100	0,4100 \$
IDM 15 MM	15,5 ± 0,5	0,35 ± 0,12	100	0,5500 \$
IDM 16 MM	16,5 ± 0,6	0,35 ± 0,12	100	0,5700 \$
IDM 18 MM	19 ± 0,6	0,40 ± 0,15	100	0,7200 \$
IDM 20 MM	20,5 ± 0,6	0,40 ± 0,15	100	0,8500 \$
IDM 22 MM	22,5 ± 0,7	0,45 ± 0,15	100	1,0500 \$
IDM 25 MM	26 ± 0,7	0,45 ± 0,15	50	1,2200 \$
IDM 30 MM	31,5 ± 0,7	0,50 ± 0,15	25	1,2900 \$
IDM 35 MM	38 ± 0,7	0,50 ± 0,15	25	1,6000 \$
IDM 40 MM	40,5 ± 0,7	0,50 ± 0,15	25	1,7500 \$
IDM 50 MM	52,5 ± 0,7	0,50 ± 0,15	25	2,4000 \$
IDM 60 MM	60,5 ± 0,8	0,52 ± 0,15	25	3,2000 \$
IDM 70 MM	70,5 ± 1.0	0,55 ± 0,15	25	3,4200 \$



## Sarı Yeşil Daralan Makaronlar

Sipariş Kodu	Boyutlar (Daralmadan önce) İç Çap	Cıdar Kalınlığı	Uzunluk mt /makara	Birim Fiyat
IDM-SY 3 MM	3,5 ± 0,4	0,20 ± 0,05	200	0,1800 \$
IDM-SY 4 MM	4,5 ± 0,4	0,20 ± 0,05	200	0,1900 \$
IDM-SY 5 MM	5,5 ± 0,4	0,20 ± 0,05	100	0,2200 \$
IDM-SY 6 MM	6,5 ± 0,4	0,22 ± 0,05	100	0,2550 \$
IDM-SY 8 MM	8,5 ± 0,4	0,30 ± 0,08	100	0,2750 \$
IDM-SY 10 MM	10,5 ± 0,5	0,30 ± 0,08	100	0,3100 \$
IDM-SY 12 MM	12,5 ± 0,5	0,30 ± 0,10	100	0,4400 \$
IDM-SY 14 MM	14,5 ± 0,5	0,33 ± 0,10	100	0,5000 \$
IDM-SY 16 MM	16,5 ± 0,6	0,35 ± 0,12	100	0,6500 \$
IDM-SY 18 MM	19 ± 0,6	0,40 ± 0,15	50	0,8000 \$
IDM-SY 20 MM	20,5 ± 0,6	0,40 ± 0,15	50	0,9500 \$
IDM-SY 25 MM	26 ± 0,7	0,45 ± 0,15	50	1,5000 \$
IDM-SY 30 MM	31,5 ± 0,7	0,50 ± 0,15	25	1,7000 \$
IDM-SY 35 MM	38 ± 0,7	0,50 ± 0,15	25	2,0000 \$
IDM-SY 40 MM	40,5 ± 0,7	0,50 ± 0,15	25	3,0000 \$
IDM-SY 50 MM	52,5 ± 0,7	0,50 ± 0,15	25	3,5000 \$



### TEKNİK ÖZELLİKLER

Malzeme : Polyolefin  
Daralma Oranı : 2/1  
Yanmazlık : Kendi kendine söner  
Çalışma Sıcaklığı : -55°C -- +125°C

YENİ  
ÜRÜN

inch	Sipariş Kodu							Makara Mt.	Fiyat
	ŞEFFAF	BEYAZ	KIRMIZI	MAVİ	SARI	YEŞİL	GRİ		
mm	mm	mm	mm	mm	mm	mm	mm		
-	1,5	1,5	1,5	1,5	1,5	1,5	1,5	200	0.095 \$
-	2,5	2,5	2,5	2,5	2,5	2,5	2,5	200	0.135 \$
1/8	3,2	3,2	3,2	3,2	3,2	3,2	3,2	200	0.148 \$
-	-	3,5	-	-	3,5	-	-	200	0.155 \$
Yassı	-	3,5	-	-	3,5	-	-	100	0.185 \$
3/16	4,8	4,8	4,8	4,8	4,8	4,8	4,8	100	0.200 \$
Yassı	-	4,8	-	-	4,8	-	-	100	0.240 \$
1/4	6,4	6,4	6,4	6,4	6,4	6,4	6,4	100	0.255 \$
Yassı	-	6,4	-	-	6,4	-	-	100	0.260 \$
Yassı	-	7	-	-	7	-	-	100	0.300 \$
3/8	9,5	9,5	9,5	9,5	9,5	9,5	9,5	100	0.350 \$
-	13	13	13	13	13	13	13	100	0.530 \$
4/5	16	16	16	16	16	16	16	100	0.700 \$
-	20	20	20	20	20	20	20	100	1.150 \$
1	25,4	25,4	25,4	25,4	25,4	25,4	25,4	50	1.500 \$
1 - 1/4	32	32	32	32	32	32	32	50	1.850 \$
1 - 1/2	38	38	38	38	38	38	38	50	2.665 \$
2	51	51	51	51	51	51	51	25	3.100 \$
-	60	60	60	60	60	60	60	25	4.200 \$
-	80	80	80	80	80	80	80	25	5.900 \$

## Kahverengi

inch	Ölçü mm	Daralmadan Önce (mm)		Daralmadan Sonra (mm)		Makara / Mt.	Fiyat
		İç Çap	Cidar Kalınlığı	İç Çap	Cidar Kalınlığı		
-	1,5	2,0 ± 0,3	0,16 ± 0,05	0,80	0,30 ± 0,05	200	0.105 \$
-	2,5	3,0 ± 0,3	0,16 ± 0,05	1,25	0,38 ± 0,05	200	0.150 \$
1/8	3,2	3,5 ± 0,4	0,20 ± 0,05	1,75	0,40 ± 0,05	200	0.165 \$
3/16	4,8	5,2 ± 0,4	0,20 ± 0,05	2,60	0,47 ± 0,08	100	0.230 \$
1/4	6,4	7,0 ± 0,4	0,28 ± 0,05	3,50	0,55 ± 0,08	100	0.300 \$
3/8	9,5	10,0 ± 0,5	0,30 ± 0,08	5,00	0,60 ± 0,08	100	0.400 \$
-	13	13,5 ± 0,5	0,33 ± 0,10	6,50	0,65 ± 0,08	100	0.600 \$
4/5	16	16,5 ± 0,6	0,35 ± 0,12	8,00	0,75 ± 0,08	100	0.800 \$
-	20	20,5 ± 0,6	0,40 ± 0,15	10,00	0,80 ± 0,15	100	1.300 \$
1	25,4	25,6 ± 0,7	0,45 ± 0,15	12,00	0,95 ± 0,15	50	1.700 \$
1 - 1/4	32	33,0 ± 0,7	0,50 ± 0,15	16,50	0,95 ± 0,15	50	2.100 \$
1 - 1/2	38	40,0 ± 0,7	0,50 ± 0,15	20,00	1,00 ± 0,15	50	2.700 \$
2	51	52,5 ± 0,7	0,50 ± 0,15	25,00	1,00 ± 0,15	25	3.200 \$
-	60	60,5 ± 0,8	0,52 ± 0,15	30,00	1,00 ± 0,16	25	4.300 \$
-	80	82,0 ± 1,0	0,55 ± 0,15	40,00	1,10 ± 0,18	25	6.000 \$

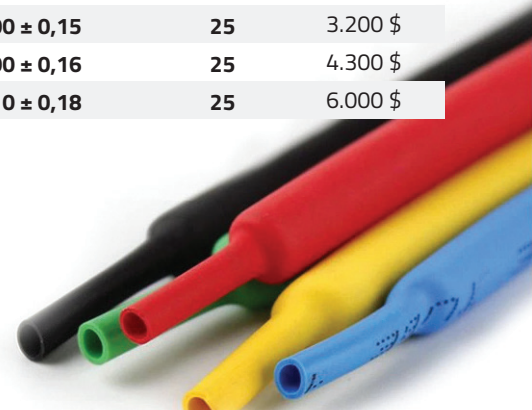

Sipariş Kodu	Kablo Kesiti	M	Ebatlar (mm)								Kutu Adet	Birim Fiyat
			d1	d4	a	d2	b	c1	c2	L		
JG6-6	6	M6	4	5.5	10.5	5.3	9	6.5	6.5	19	1000	0,200 \$
JG10-6	10	M6	4.5	6	12.5	5.3	9	7	7	21	1000	0,350 \$
JG16-6	16	M6	5.5	7.5	13.5	6.4	11.5	7.5	7.5	24	500	0,400 \$
JG16-10	16	M10	5.5	7.5	13.5	6.4	11.5	7.5	7.5	24	500	0,400 \$
JG25-8	25	M8	7	9.5	16.5	8.5	13.5	8.5	8.5	27	250	0,570 \$
JG35-8	35	M8	8.5	11	17.5	8.5	16	9.5	9.5	32	200	0,700 \$
JG50-10	50	M10	10	13	19	10.5	19	11	11	37.5	75	0,950 \$
JG70-10	70	M10	11.5	14.5	21	10.5	21	11	11	40	50	1,800 \$
JG95-12	95	M12	13.5	16.5	23	13	24	12.5	12.5	44	25	2,200 \$
JG120-12	120	M12	14.5	18	25	13	26.5	14	14	49	25	3,200 \$
JG150-12	150	M12	16.5	21	28	13	30.5	15.5	15.5	55	25	3,700 \$
JG185-14	185	M14	18.5	23	32	13	34.5	16	16	61	25	6,200 \$
JG240-16	240	M16	21	26	36	13	37.5	16.5	16.5	68	20	7,600 \$

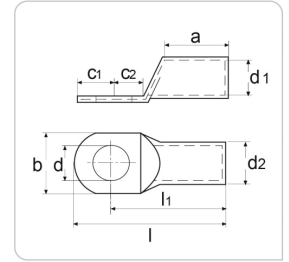

## BiMetal (Al-Cu) Kablo Pabucu

Ürün Kodu	Kablo Kesiti	Delik Çapı Ø	Boyutlar (mm)					Kutu Adet	Birim Fiyatı
			d	D	l1	L	B		
DTL2-16	16 mm <sup>2</sup>	M10	5.5	16	43	85	21	80	2,00 \$
DTL2-25	25 mm <sup>2</sup>	M10	6.5	16	43	85	21	80	2,00 \$
DTL2-35	35 mm <sup>2</sup>	M10	8.0	16	43	85	21	80	2,00 \$
DTL2-50	50 mm <sup>2</sup>	M12	9.0	20	43	90	25.6	50	2,80 \$
DTL2-70	70 mm <sup>2</sup>	M12	11.0	20	43	90	25.6	50	2,80 \$
DTL2-95	95 mm <sup>2</sup>	M12	12.5	20	43	90	25.6	50	2,80 \$
DTL2-120	120 mm <sup>2</sup>	M12	13.7	25	59	115	30	30	5,00 \$
DTL2-150	150 mm <sup>2</sup>	M12	15.5	25	59	115	30	30	5,00 \$
DTL2-185	185 mm <sup>2</sup>	M12	17.0	32	60	122	35	15	8,70 \$
DTL2-240	240 mm <sup>2</sup>	M12	19.5	32	60	122	35	15	8,70 \$
DTL2-300	300 mm <sup>2</sup>	M12	23.5	34	65	127	35	15	9,70 \$
DTL2-400	400 mm <sup>2</sup>	M16	26.0	40	90	160	36	9	14,50 \$

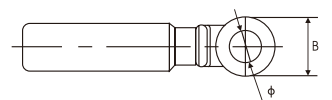
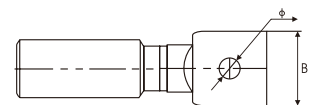
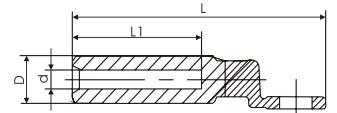





Boy	Gri Kodu	Siyah Kodu	Montaj Çap/mm	Kutu Adedi	Fiyat
PG-7	PG-7G	PG-7S	7	450	0,0850 \$
PG-9	PG-9G	PG-9S	8	300	0,1100 \$
PG-11	PG-11G	PG-11S	10	200	0,1360 \$
PG-13,5	PG-13,5G	PG-13,5S	12	175	0,1600 \$
PG-16	PG-16G	PG-16S	14	125	0,2100 \$
PG-21	PG-21G	PG-21S	18	75	0,3500 \$
PG-29	PG-29G	PG-29S	25	40	0,6100 \$
PG-36	PG-36G	PG-36S	32	20	1,0500 \$
PG-42	PG-42G	PG-42S	38	15	1,4500 \$

## PG DİŞ GEÇMELİ TİP SİRİAL RAKORLAR



Gri Kodu	Siyah Kodu	Spiral Ölçü mm	Kutu Adedi	Fiyat
AD10-PG7 G	AD10-PG7 S	6,5 x 10	100	0,240 \$
AD13-PG9 G	AD13-PG9 S	10 x 13	50	0,300 \$
AD15,8-PG11 G	AD15,8-PG11 S	12 x 15,8	50	0,380 \$
AD18,5-PG13,5 G	AD18,5-PG13,5 S	14,2 x 18,4	75	0,450 \$
AD21,2-PG16 G	AD21,2-PG16 S	16,5 x 21,2	50	0,650 \$
AD28,5-PG21 G	AD28,5-PG21 S	23,5 x 28,4	25	1,000 \$
AD34,5-PG29 G	AD34,5-PG29 S	29 x 34,5	20	1,350 \$
AD42,5-PG36 G	AD42,5-PG36 S	36 x 42,5	15	1,750 \$
AD54,5-PG48 G	AD54,5-PG48 S	48 x 54,5	10	2,600 \$

## Polyamid Körtapa



Boy	Gri Kodu	Siyah Kodu	Montaj Çap/mm	Kutu Adedi	Fiyat
PG-7	KTG-PG7	KTS-PG7	13	100	0,060 \$
PG-9	KTG-PG9	KTS-PG9	16	100	0,065 \$
PG-11	KTG-PG11	KTS-PG11	19	100	0,090 \$
PG-13,5	KTG-PG13,5	KTS-PG13,5	21	100	0,100 \$
PG-16	KTG-PG16	KTS-PG16	23	100	0,130 \$
PG-21	KTG-PG21	KTS-PG21	29	50	0,200 \$
PG-29	KTG-PG29	KTS-PG29	37,5	25	0,330 \$
PG-36	KTG-PG36	KTS-PG36	47,5	25	0,550 \$
PG-48	KTG-PG48	KTS-PG48	60	5	1,200 \$

## POLYAMİD SOMUN



Boy	Gri Kodu	Siyah Kodu	Montaj Çap/mm	Kutu Adedi	Fiyat
PG-7	SG-PG7	SS-PG7	19	100	0,035 \$
PG-9	SG-PG9	SS-PG9	22	100	0,034 \$
PG-11	SG-PG11	SS-PG11	24	100	0,035 \$
PG-13,5	SG-PG13,5	SS-PG13,5	27	100	0,043 \$
PG-16	SG-PG16	SS-PG16	30	100	0,047 \$
PG-21	SG-PG21	SS-PG21	36	50	0,071 \$
PG-29	SG-PG29	SS-PG29	46	25	0,130 \$
PG-36	SG-PG36	SS-PG36	60	25	0,210 \$
PG-48	SG-PG48	SS-PG48	70	10	0,380 \$

## POLYAMİD KAPAKLI KROŞELER



Gri Kodu	Siyah Kodu	Spiral Ölçü mm	Kutu Adedi	Fiyat
KON-PG7 G	KON-PG7 S	10	50	0,320 \$
KON-PG9 G	KON-PG9 S	13	50	0,380 \$
KON-PG11 G	KON-PG11 S	15,8	50	0,400 \$
KON-PG13,5 G	KON-PG13,5 S	18,4	50	0,450 \$
KON-PG16 G	KON-PG16 S	21,2	50	0,500 \$
KON-PG21 G	KON-PG21 S	28,4	25	0,720 \$
KON-PG29 G	KON-PG29 S	34,5	25	0,850 \$
KON-PG36 G	KON-PG36 S	42,5	25	1,050 \$
KON-PG48 G	KON-PG48 S	54,5	10	1,200 \$



ISISO ENDÜSTRİYEL OTOMASYON ÜRÜNLERİ

# Fanlar, Pedallar, Switchler, Silikon, Cam Elyaf Kablolar



[www.soyluotomasyon.com](http://www.soyluotomasyon.com)



## Pano İçi Termostatlar

Kod	Kontakt	Açıklama ve Çalışma Sıcaklığı	Kutu Adedi	Fiyat
IPT-K	NC	Isıtma Termostatı (0 - 60°C)	1	5,60 \$
IPT-M	NO	Soğutma Termostatı (0 - 60°C)	1	5,60 \$

Ürün Ölçüleri : 60 x 33 x 34

## Endüstriyel Fanlar ve Filtreler

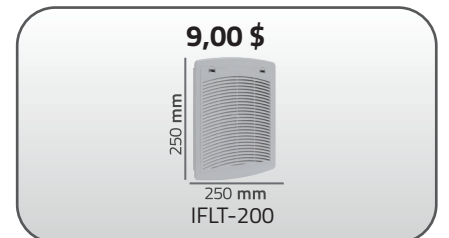
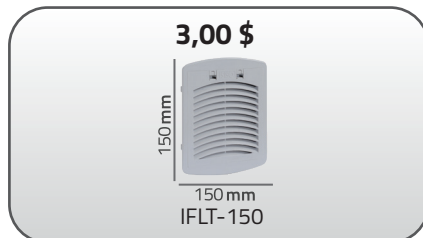
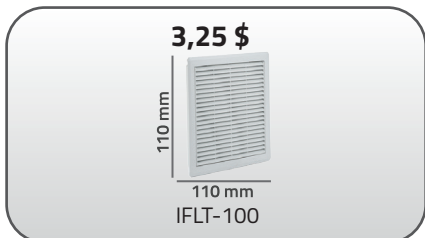
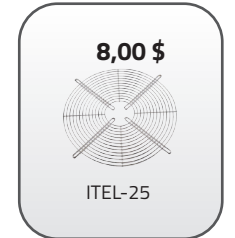
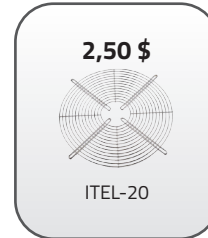
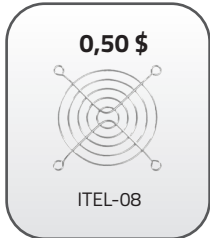
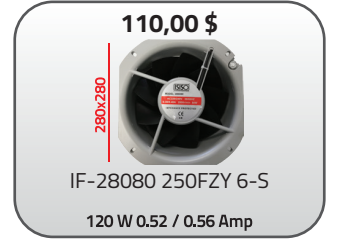
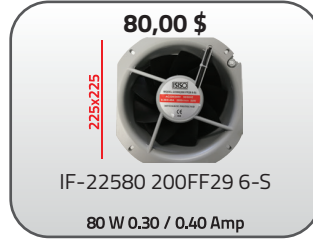
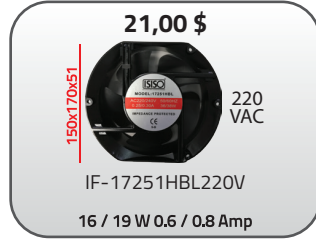
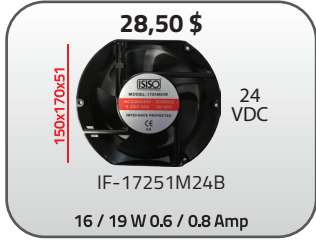
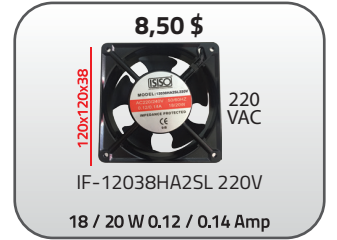
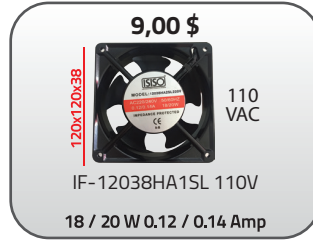
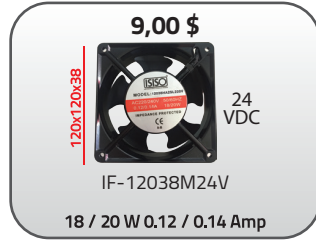
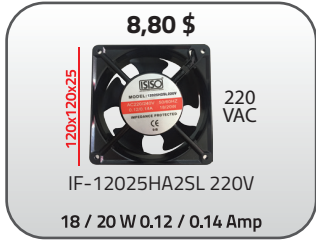
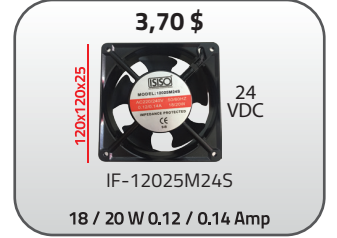
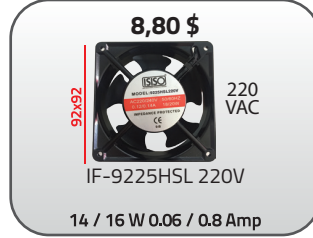
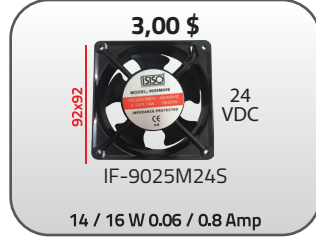
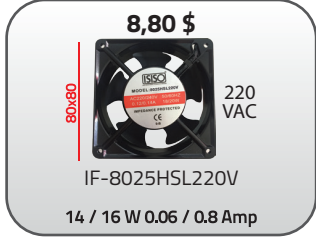
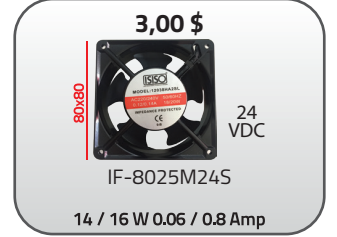
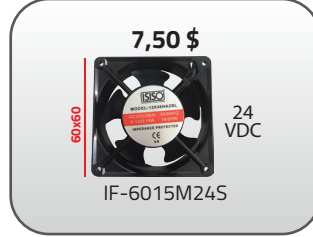
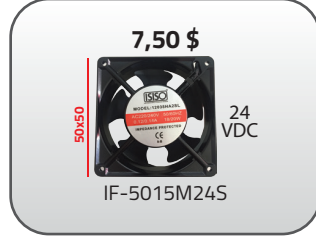
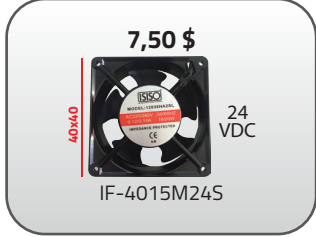



















## Metal Gövde

<p><b>TSA-001</b> 10.50 \$</p> 	<p><b>TSA-003</b> 11.00 \$</p> 	<p><b>TSA-021</b> 10.50 \$</p> 	<p><b>TSA-031</b> 12.00 \$</p> 	<p><b>TSA-012</b> 12.00 \$</p> 
<p><b>TSA-041</b> 12.00 \$</p> 	<p><b>TSA-051</b> 12.50 \$</p> 	<p><b>TSA-081</b> 12.00 \$</p> 	<p><b>TSA-071</b> 12.00 \$</p> 	<p><b>TSA-061</b> 12.00 \$</p> 



## Kablolu Mini Switch

<p><b>TZ-3101</b> 30.00 \$</p>  <p>Waterproof (Su Geçirmez) Limit Switch</p>	<p><b>TZ-3110</b> 30.00 \$</p>  <p>Waterproof (Su Geçirmez) Limit Switch</p>	<p><b>TZ-3102</b> 30.00 \$</p>  <p>Waterproof (Su Geçirmez) Limit Switch</p>	<p><b>TZ-3112</b> 30.00 \$</p>  <p>Waterproof (Su Geçirmez) Limit Switch</p>
<p><b>TZ-3104</b> 30.00 \$</p>  <p>Waterproof (Su Geçirmez) Limit Switch</p>	<p><b>TZ-3108</b> 30.00 \$</p>  <p>Waterproof (Su Geçirmez) Limit Switch</p>	<p><b>TZ-3107</b> 30.00 \$</p>  <p>Waterproof (Su Geçirmez) Limit Switch</p>	<p><b>TZ-3166</b> 30.00 \$</p>  <p>Waterproof (Su Geçirmez) Limit Switch</p>





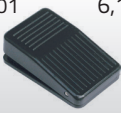
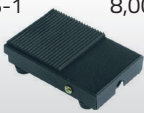
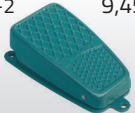
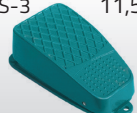
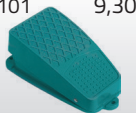
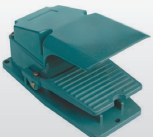
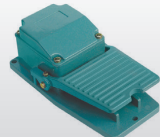
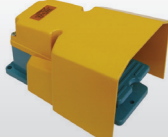









## Emniyet Switch

<p><b>T4N-4A32R</b> 12.50 \$</p>  <p>Safety(Güvenlik) Limit Switch</p>	<p><b>T4N-4A25R</b> 12.50 \$</p>  <p>Safety(Güvenlik) Limit Switch</p>	<p><b>T4N-4A2HR</b> 12.50 \$</p>  <p>Safety(Güvenlik) Limit Switch</p>	<p><b>T4N-4A2MR</b> 12.50 \$</p>  <p>Safety(Güvenlik) Limit Switch</p>	<p><b>1NO+1NC</b> 3.00 \$</p>  <p>Switch Konağı</p>
---	---	---	---	--

## Pedallar

<p><b>TFS-01</b> 6,10 \$</p>  <p>Plastik Gövde 1NO + 1NC</p>	<p><b>TFS-1</b> 8,00 \$</p>  <p>Metal Gövde 1NO + 1NC</p>	<p><b>TFS-2</b> 9,45 \$</p>  <p>Alüminyum Gövde 1NO + 1NC</p>	<p><b>TFS-3</b> 11,50 \$</p>  <p>Alüminyum Gövde 1NO + 1NC</p>	<p><b>TFS-101</b> 9,30 \$</p>  <p>Alüminyum Gövde 1NO + 1NC</p>
<p><b>TFS-304</b> 27,00 \$</p>  <p>Alüminyum Gövde 2NO + 2NC</p>	<p><b>TFS-404</b> 25,00 \$</p>  <p>Alüminyum Gövde 1NO + 1NC</p>	<p><b>TFS-502</b> 37,00 \$</p>  <p>Alüminyum Gövde 1NO + 1NC</p>	<p><b>TFS-602</b> 87,00 \$</p>  <p>Alüminyum Gövde 2NO + 2NC</p>	



## Mini Switch

<p>TM-1300 3,60 \$</p>  <p>Kısa ince pimli</p>	<p>TM-1301 3,60 \$</p>  <p>Kısa ince pimli paletli</p>	<p>TM-1303 4,25 \$</p>  <p>Kısa ince pimli paletli makaralı</p>	<p>TM-1305 4,25 \$</p>  <p>İnce uzun pimli</p>	<p>TM-1306 3,60 \$</p>  <p>Kısa kalın pimli</p>
<p>TM-1307 4,25 \$</p>  <p>Uzun kalın pimli</p>	<p>TM-1308 4,60 \$</p>  <p>Yatay metal makaralı pimli</p>	<p>TM-1309 4,60 \$</p>  <p>Dikey metal makaralı pimli</p>	<p>TM-1701 3,60 \$</p>  <p>Uzun paletli</p>	<p>TM-1702 3,60 \$</p>  <p>Kısa paletli</p>
<p>TM-1703 3,60 \$</p>  <p>Uzun paletli metal makaralı</p>	<p>TM-1704 3,60 \$</p>  <p>Kısa paletli metal makaralı</p>	<p>TM-1743 4,25 \$</p>  <p>Tahrikli kısa metal makaralı</p>	<p>TOW 0,60 \$</p>  <p>Toggle anahtar koruma kılıfı</p>	<p>TAP-Y 0,50 \$</p>  <p>Mini switch koruma kapağı 45°</p>
<p>TM-1705 3,90 \$</p>  <p>Uzun tel paletli</p>			<p>TM-1724 4,15 \$</p>  <p>Uzun paletli</p>	





## Mikro Switch

<p>V-15-1C25 0,95 \$</p>  <p>Buton pimli tip</p>	<p>V-151-1C25 1,00 \$</p>  <p>Kısa paletli</p>	<p>V-152-1C25 1,00 \$</p>  <p>Orta paletli</p>	<p>V-153-1C25 1,00 \$</p>  <p>Uzun paletli</p>
<p>V-154-1C25 1,00 \$</p>  <p>Çengel paletli</p>	<p>V-155-1C25 1,00 \$</p>  <p>Kısa palet plastik makaralı</p>	<p>V-156-1C25 1,00 \$</p>  <p>Uzun palet plastik makaralı</p>	

## Güç Anahtarı

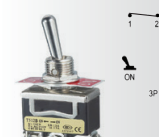
<p>TBSN-310 7,00 \$</p>  <p>Metal Gövde</p> <p>3 Faz 1.5 KW 10A</p>	<p>TBSN-315 8,00 \$</p>  <p>Metal Gövde</p> <p>3 Faz 2.2 KW 15A</p>	<p>TBSN-330 9,00 \$</p>  <p>Metal Gövde</p> <p>3 Faz 3.7 KW 30A</p>
--	--	--

## Toggle Anahtar

<p>T511B 2,50 \$</p>  <p>Kalıcı 2pin On/off toggle anahtar</p>	<p>T512B 2,60 \$</p>  <p>Kalıcı 3pin On/on toggle anahtar</p>	<p>T513B 2,60 \$</p>  <p>Kalıcı 3pin On/off/on toggle anahtar</p>	<p>T521B 3,00 \$</p>  <p>Kalıcı 4pin On/off toggle anahtar</p>	<p>T522B 3,30 \$</p>  <p>Kalıcı 6pin On/on toggle anahtar</p>	<p>T523B 3,30 \$</p>  <p>Kalıcı 6pin On/off/on toggle anahtar</p>
--	--	--	---	--	--

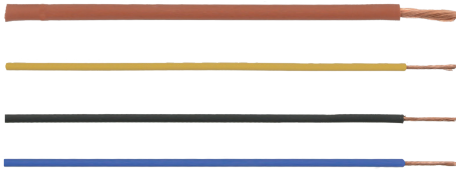

### SiAF-Silikon Kablo

0,50 Silikon	8,00 TL
0,75 Silikon	10,90 TL
1'lik Silikon	13,80 TL
1,5'lik Silikon	18,60 TL
2,5'luk Silikon	31,00 TL
4'lük Silikon	49,60 TL
6'luk Silikon	76,80 TL
10'luk Silikon	131,20 TL
16'luk Silikon	217,60 TL



### SiAF-GL Cam İplik Örgülü Kablo

0,50'lik Cam Elyaf Kablo	16,80 TL
0,75'lik Cam Elyaf Kablo	20,30 TL
1'lik Cam Elyaf Kablo	25,30 TL
1,5'luk Cam Elyaf Kablo	32,00 TL
2,5'luk Cam Elyaf Kablo	48,00 TL
4'lük Cam Elyaf Kablo	75,20 TL
6'luk Cam Elyaf Kablo	109,00 TL
10'luk Cam Elyaf Kablo	192,00 TL
16'luk Cam Elyaf Kablo	320,00 TL

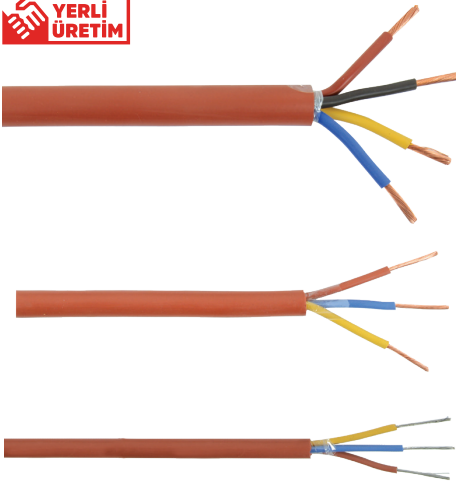

### SiMH-Silikon Kablo

2x0,50	33,60 TL
2x0,75	43,20 TL
2x1	51,20 TL
2x1,5	64,00 TL
2x2,5	92,80 TL
3x0,50	43,20 TL
3x0,75	53,60 TL
3x1	68,80 TL
3x1,5	88,00 TL
3x2,5	128,00 TL
4x1	84,80 TL
4x1,5	105,60 TL
4x2,5	172,80 TL
4x4	272,00 TL

## Pano İçi Aydınlatma Ledleri

LD-17-24

LD-31-24

LD-60-24



Ürün Kodu	Besleme	Renk	Ebat	Fiyat
LD-17-...	12 VDC - 24 VDC - 220 VAC	Beyaz - Gün Işıği	170x190 mm	16 \$
LD-31-...	12 VDC - 24 VDC - 220 VAC	Beyaz - Gün Işıği	310x190 mm	21 \$
LD-60-...	12 VDC - 24 VDC - 220 VAC	Beyaz - Gün Işıği	600x190 mm	27 \$

Not: İstenilen ölçü & voltajlarda led imalatı yapılır.



IS-Ti1 1,40\$



IS-Ti2 1,10\$



IS-Ti3 0,75\$

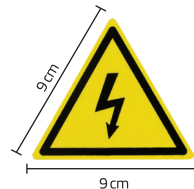

IS-Ti4 0,75\$

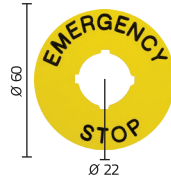

IS-60P 2,20\$



ISISO ENDÜSTRİYEL OTOMASYON ÜRÜNLERİ

## Analog Girişli Monofaze / Trifaze Lineer (4-20mA) SSR'ler

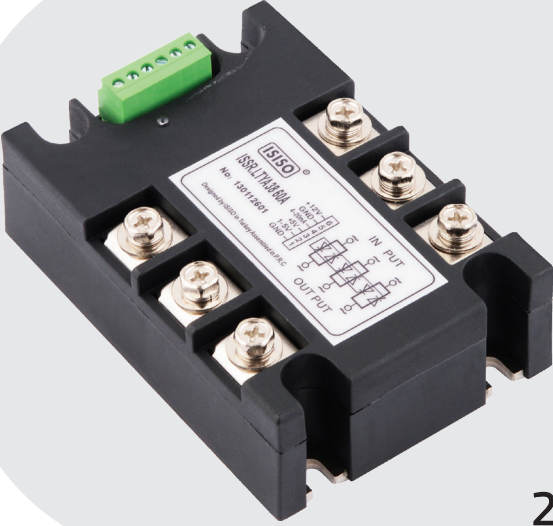

28. SAYFA'DA

## Termokupl Analog Çeviriciler



Kafa İçi

PT-100 / PT1000 4-20 mA Ayarlanabilir  
J Tipi / K Tipi



Ray Tipi

PT-100 / PT1000 4-20 mA Ayarlanabilir  
J Tipi / K Tipi



D148

USB Programlama Kablosu

15. SAYFA'DA





ISISO ENDÜSTRİYEL OTOMASYON ÜRÜNLERİ

Firmamız **SOYLU OTOMASYON L.T.D. Ş.T.İ.** 20 yılı aşan tecrübesiyle Elektrik-Elektronik ve Otomasyon sektörlerinde hızla artan ivmesiyle endüstrinin nabzını tutan, yeniliklere açık, güvenilir ve gelişmeci bir firma olmuştur. Kurulduğu günden bugüne kadar üretim, satış ve proje odaklı bir sürece hizmet ederek birçok konuda adından söz ettirmeyi başarmıştır. ISISO markası ile termokupl imalatıyla sektöre giriş yapan firmamız bugün itibariyle binlerce firmaya standart ve özel tip termokupl üretmektedir. Bunun dışında ISISO markası ile servo motor ve sürücüler, AC hız kontroller, güç kaynakları, sensörler, butonlar, sinyal lambaları ve ss'ler, kablo yüksükleri, yapışkanlı kroşeler, yanmaz ve daralan makaronlar ve kablo bağlarını müşterilerine sunmaktadır. Uzman mühendis tekniker ve teknisyen kadrosuyla sattığı tüm ürünlerin arkasında durmaktadır.

**soylu** elektrik  
otomasyon



**Merkez**

İkitelli Org. San. Böl. Aykosan Sanayi Sitesi  
Çarşı 1 Blok No:193 **Başakşehir** / İSTANBUL  
Telefon : +90 212 671 33 56 Pbx  
Satış Fax : +90 212 671 33 60  
Muhasebe Fax : +90 212 549 40 62  
E-Posta : info@soyluotomasyon.com

**Şube 1**

Çakmaklı Mah. İnkılap Sok. No:3  
**Büyükkçekmece** / İSTANBUL  
Telefon : +90 212 886 90 54 Pbx  
Satış Fax : +90 212 886 45 31

**Şube 2**

Bereket Zade Mah. Okçumusa Cad.  
Yücel Han No:13-1 **Karaköy** / İSTANBUL  
Telefon : +90 212 251 71 10 Pbx  
Satış Fax : +90 212 251 71 35

